

CETAC U-5000AT⁺ and U-6000AT⁺ Ultrasonic Nebulizers

OPERATOR'S ACCESSORIES AND SUPPLIES CATALOG



CETAC U-5000AT⁺ Ultrasonic Nebulizer



CETAC U-6000AT⁺ Ultrasonic Nebulizer
with Membrane Desolvator

Kel-F is a registered trademark of 3M Co.

Kalrez, Viton, Tefzel, and Teflon are registered trademarks of E.I. Du Pont de Nemours and Co.

Tygon is a registered trademark of Norton Co.

Chemraz is a registered trademark of Greene, Tweed and Co.

PEEK polymer is a trademark of Victrex plc.

SD Acquisition, Inc.
d.b.a. CETAC Technologies
14306 Industrial Road
Omaha, NE 68144-3334 USA
Phone: (402) 733-2829
Fax: (402) 733-5292
e-mail: custserv@cetac.com



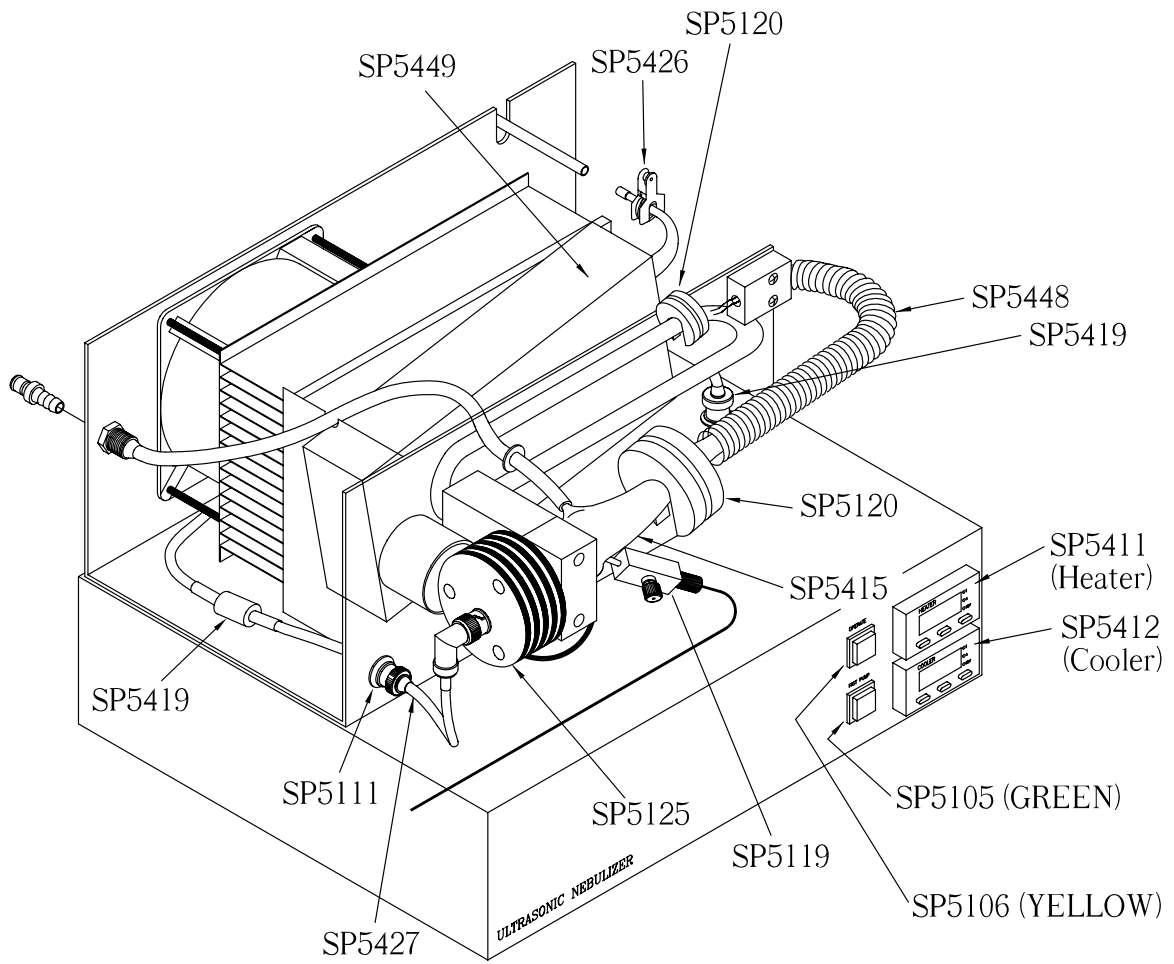

620052 Version 1.0, April, 2001





U-5000AT⁺ and U-6000AT⁺ Ultrasonic Nebulizers Spare Parts

	PART #
	1. Fuse kit SP5410
	2. Temperature controller, heater (Also used on membrane desolvator for U-6000AT ⁺) SP5411
	3. Temperature controller, cooler SP5412
	4. Drain pump kit with motor kit SP5431

U-5000AT⁺ and U-6000AT⁺ Ultrasonic Nebulizers Spare Parts

	PART #
 A photograph of a drain pump head assembly, consisting of a black rectangular component, a circular white plate with four screws, and a white curved arm with a black tip.	5. Drain pump head assembly SP5122C
 A photograph of an aerosol spray chamber, a clear plastic cylindrical component with a central nozzle and a side inlet.	6. Aerosol spray chamber SP5415
 A photograph of a heated J-tube assembly, featuring a clear glass J-tube with a white corrugated heating jacket and a black connector.	7. Heated J-tube assembly SP5448
 A photograph of a cooler assembly, a white rectangular unit with a black fan and copper tubing connections.	8. Cooler assembly SP5449
 A photograph of a 12/5 glass socket adapter for ultrasonic nebulizer outlet, a clear glass component with a white plastic socket.	9. 12/5 glass socket adapter for ultrasonic nebulizer outlet SP5160



U-5000AT⁺ and U-6000AT⁺ Ultrasonic Nebulizers Spare Parts

	PART #
	<p>10. Clamp for 12/5 glass socket adapter SP5426</p>
	<p>11. Ball joint clamp kit (Includes clamps for both ends of the heated "u" tube assembly). SP5120</p>
	<p>12. Sample inlet adapter assembly (Includes Kel-F® adapter and PEEK™ tubing). SP5119</p>
	<p>13. Spare transducer assembly SP5125 Spare transducer assembly, rebuild (North American orders only) SP5134</p>



U-5000AT⁺ and U-6000AT⁺ Ultrasonic Nebulizers Spare Parts

	PART #
	14. Transducer cable SP5427
	15. Inline inductor cable SP5419
	16. Feed through BNC connector kit (2 connectors per kit) SP5111
	17. Circuit breaker, 3 amp SP5153





U-5000AT⁺ and U-6000AT⁺ Ultrasonic Nebulizers Spare Parts

	PART #
	<p>18. Argon connector kit</p> <p style="text-align: right;">SP5413</p>
	<p>19. Argon in flow restrictor 500 mL / min (blue color band) SP5156</p> <p>Argon in flow restrictor 1000 mL / min (red color band) SP5156B</p>
	<p>20. Hex (allen) wrench</p> <p style="text-align: right;">SP5172</p>
	<p>21. U-6000AT⁺ glassware module cover SP5450</p> <p>U-5000AT⁺ glassware module cover SP5451</p>



U-5000AT⁺ and U-6000AT⁺ Ultrasonic Nebulizers Spare Parts

		PART #
	22. Glassware module	SP5409
	23. Electronics module, 100 / 115V	SP5422
	Electronics module, 220 / 240V	SP5423



U-5000AT⁺ and U-6000AT⁺ Tubing and O-Ring Kits

	<p style="text-align: right;">PART #</p> <p>Spare parts kit. Includes each of the following: Sample inlet tubing, sample out tubing, rinse tubing, drain tubing, sample inlet peristaltic pump tubing (package of 12 each), drain peristaltic pump tubing, and aerosol chamber o-ring</p> <p style="text-align: right;">SP5447</p>
	<p>Drain pump tubing and connector kit</p> <p style="text-align: right;">SP5366</p>
	<p>Acid proof o-ring kit. Contains aerosol chamber o-ring and u-tube ball joint o-rings</p> <p style="text-align: right;">SP5126</p>
	<p>Aerosol chamber o-ring (2 per kit):</p> <p>Kalrez® – recommended for analysis of corrosive chemicals and element determination at low levels (ppb)</p> <p style="text-align: right;">SP5168</p> <p>Chemraz® – recommended for analysis of corrosive chemicals and element determination at ultra low levels (sub ppb)</p> <p style="text-align: right;">SP5168B</p>

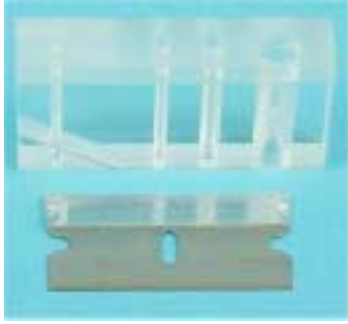
U-5000AT⁺ and U-6000AT⁺ Tubing and O-Ring Kits

	PART #
	<p>Sample uptake peristaltic pump tubing, gray/gray color code, 1.3 mm I.D. (12 per package) SP5136</p>
	<p>Teflon® sample inlet tubing, 1.5 mm O.D. x 0.8 mm I.D., 25 ft. (7.6m) SP5150A</p>
	<p>PEEK (polyetheretherketone) sample inlet tubing to be used with rectangular Kel-F® adapters. (1.6 mm O.D. x 0.5 mm I.D. x 45.7 cm long) SP5150B</p> <p>Tefzel® sample inlet tubing for higher conc. (> 10%) acid samples. To be used instead of PEEK™ (polyetheretherketone) sample inlet tubing normally supplied with unit (1.6 mm O.D. x 0.5 mm I.D. x 45.7 cm long) SP5151</p>
	<p>Tubing cutter (includes cutting blade) SP5170</p>

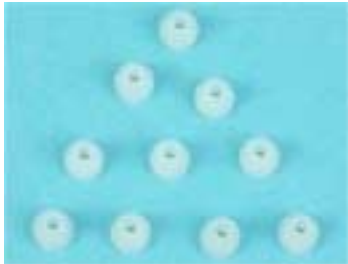
U-5000AT⁺ and U-6000AT⁺ Tubing and O-Ring Kits

	PART #
	Ferrule replacement kit for sample inlet tube (10 ferrules per kit) SP6007
	Extension tubing kit. Can be used with PEEK™ (polyetheretherketone) sample inlet tubing normally supplied with unit or Tefzel® sample inlet tubing. Contains 3 ft. (0.9 m) of Tefzel® tubing with connector SP5154
	Sample out tubing kit. Contains 5 ft. (1.5 m) of Tygon® tubing, 5/16 in. O.D. x 3/16 in. I.D. SP5159



U-5000AT⁺ and U-6000AT⁺ ICP Adapters

	PART #
	<p>PerkinElmer spray chamber adapter for Plasma II, Plasma 40, Plasma 400 Plasma 1000, Plasma 2000, ICP5000 ICP5500, ICP6000, and ICP6500 ICP-AES instruments. SP5137</p>
	<p>PerkinElmer ICP-AES torch adapter (pre-Optima) for Plasma II, Plasma 40, Plasma 400, Plasma 1000, Plasma 2000, ICP5000, ICP5500, ICP6000, and ICP6500 ICP-AES instruments SP5138</p>
	<p>PerkinElmer/Sciex ELAN 5000, 6000, and 6100 ICP-MS torch adapter SP5167</p> <p>NOTE: ELAN 6100DRC requires SP5160 (below).</p>
	<p>Torch adapter, 12/5 glass socket SP5160</p>

U-5000AT⁺ and U-6000AT⁺ ICP Adapters

	PART #
	<p>Thermo Jarrell Ash (TJA) spray chamber insert adapter for TJA 900, 975, 1100, ICAP 61 and ICAP 61E ICP-AES instruments</p> <p style="text-align: right;">SP5162</p> <p>NOTE: Adapter is for a cylindrical Scott-type spray chamber.</p>
	<p>Torch adapter for all Jobin Yvon (JY) radial-viewing ICP-AES instruments produced since 1990</p> <p style="text-align: right;">SP5163</p>
	<p>Torch adapter for Varian Liberty 100, 150, and 200 Series ICP-AES instruments and Varian Ultramass-700 ICP-MS instrument.</p> <p style="text-align: right;">SP5166</p>
	<p>PerkinElmer Optima ICP-AES torch adapter for radial-viewing ICPs: Optima 3000, Optima 3000 SC(R), Optima 3100R, Optima 3200R, Optima 3300R</p> <p style="text-align: right;">SP5455</p>

U-5000AT⁺ and U-6000AT⁺ ICP Adapters

	PART #
	<p>PerkinElmer Optima torch adapters for axial and dual-viewing ICPs: Optima 3000XL, Optima 3000SC(X) Optima 3000SC(DV), Optima 3100XL or DV, Optima 3200XL or DV, Optima 3300XL or DV</p> <p style="text-align: right;">SP6003</p>
	<p>Torch adapter for PerkinElmer Optima 2000DV, 4100DV, 4200DV, and 4300DV ICP-AES instruments</p> <p style="text-align: right;">SP6005</p>
	<p>Torch adapter for TJA 61E (radial and axial), Atomscan Advantage (radial and axial), Trace Analyzer and Trace 61E, IRIS Advantage (axial, radial or dual) and IRIS Intrepid (axial, radial or dual) ICP-AES instruments</p> <p style="text-align: right;">SP6006</p>

U-5000AT⁺ and U-6000AT⁺ Interface Kits

	PART #	
	Interface kit for ARL 3410 ICP-AES instruments	SP5155
	Interface kit for GBC Integra ICP-AES instruments	SP5155G
	Interface kit for LECO Renaissance 115 TOF-ICP-MS instrument	SP5155H
	Interface kit for Philips ICP-AES instruments	SP5155M
	Interface kit for all Spectro ICP-AES instruments and Spectromass 2000 ICP-MS instrument	SP5155P
	Interface kit for VG Elemental PQ2, PQ3, PQE, Excel, and Axiom ICP-MS instruments	SP5155T
	Interface kit for all Yokogawa ICP-MS instruments	SP5155U
	Interface kit for Micromass Platform and Isoprobe ICP-MS instruments	SP5155GG
	Interface kit for Finnigan Element and Neptune ICP-MS instruments	SP5155EE
Interface kit for HP/Agilent 4500 and Agilent 7500 ICP-MS instruments	SP5155Y	
Interface kit for Shimadzu ICP-AES instruments	SP5155Z	
	Interface kit for ARL 3510, 3520, 3560, 3580, and MAXIM ICP-AES instruments	SP5155B



U-5000AT⁺ and U-6000AT⁺ Interface Kits

	PART #
	<p>Interface kit for Baird 2000 and 2070 ICP-AES instruments</p> <p>SP5155C</p>
	<p>Interface kit for NJA (Nippon Jarrell Ash) ICP-AES instruments</p> <p>SP5155E</p> <p>Interface kit for TJA Atomscan 16, 25, and ICAP 61 and 61E ICP-AES instruments</p> <p>SP5155R</p> <p>NOTE: Adapter is for instruments with a Scott-type cylindrical spray chamber.</p>
	<p>Interface kit for all radial-viewing Jobin Yvon (JY) ICP-AES instruments produced after 1990</p> <p>SP5155F</p>
	<p>Interface kit for Hitachi ICP-AES instruments</p> <p>SP5155X</p>

U-5000AT⁺ and U-6000AT⁺ Interface Kits

	PART #
	<p>Interface kit for PerkinElmer Optima radial-viewing ICP-AES instruments: Optima 3000, Optima 3000SC(R), Optima 3100R, Optima 3200R, Optima 3300R</p> <p style="text-align: right;">SP5155AA</p>
	<p>Interface kit for PerkinElmer Optima 3000XL, Optima 3000SC(X), Optima 3000SC(DV), Optima 3100XL or DV, Optima 3200XL or DV, and Optima 3300XL or DV ICP-AES instruments</p> <p style="text-align: right;">SP5155BB</p>
	<p>Interface kit for TJA 61E (radial and axial), Atomscan Advantage (radial and axial), Trace Analyzer and Trace 61E, IRIS Advantage (axial, radial, or dual) and IRIS Intrepid (axial, radial or dual) ICP-AES instruments</p> <p style="text-align: right;">SP5155CC</p>
	<p>Interface kit for Leeman Labs PS900 PS950, PS1000, PS2000, PS3000, DRE, and Profile ICP-AES instruments</p> <p style="text-align: right;">SP5155I</p>



U-5000AT⁺ and U-6000AT⁺ Interface Kits

	PART #
	<p>Interface kit for Varian Liberty 100, 150, and 200 Series, Liberty II Series, Vista MPX and Vista Pro ICP-AES instruments; interface kit for Varian Ultramass-700 ICP-MS instruments</p> <p style="text-align: right;">SP5155S</p>
	<p>Interface kit for PerkinElmer Plasma II, Plasma 40, Plasma 400, Plasma 1000, Plasma 2000, ICP5000, ICP5500, ICP6000, and ICP6500 ICP-AES instruments</p> <p style="text-align: right;">SP5155K</p>
	<p>Interface kit for all PerkinElmer/Sciex ELAN ICP-MS instruments (250, 500, 5000, 6000, 6100, 6100DRC) and Perkin Elmer Optima 2000DV, 4100DV, 4200DV and 4300DV ICP-AES instruments.</p> <p style="text-align: right;">SP5155L</p>
	<p>Interface kit for Seiko ICP-AES instruments</p> <p style="text-align: right;">SP5155O</p>

U-5000AT⁺ and U-6000AT⁺ Interface Kits

	<p style="text-align: right;">PART #</p> <p>Interface kit for TJA 900, 975, 1100 and ICAP 61 and ICAP 61E ICP-AES instruments SP5155Q</p> <p>NOTE: Adapter is for instruments with a Scott-type cylindrical spray chamber.</p>
---	---

U-5000AT⁺ and U-6000AT⁺ Catalogs and Manuals

	<p>Operators Manual for U-5000AT⁺ Ultrasonic Nebulizer SP5428</p> <p>Service Manual for U-5000AT⁺ Ultrasonic Nebulizer SP5429</p>
	<p>Operators Manual for U-6000AT⁺ Ultrasonic Nebulizer SP5452</p> <p>Service Manual for U-6000AT⁺ Ultrasonic Nebulizer SP5453</p>
	<p>Operator's Catalog SP6000</p> <p>Engineer's Catalog SP6001</p>