

Service Spare Parts

RC3BP+ (Facelift)

RC 12BP+

RC Bios

Cryofuge 6000i / 8500i (Facelift)

PN: 12007030 rev.02

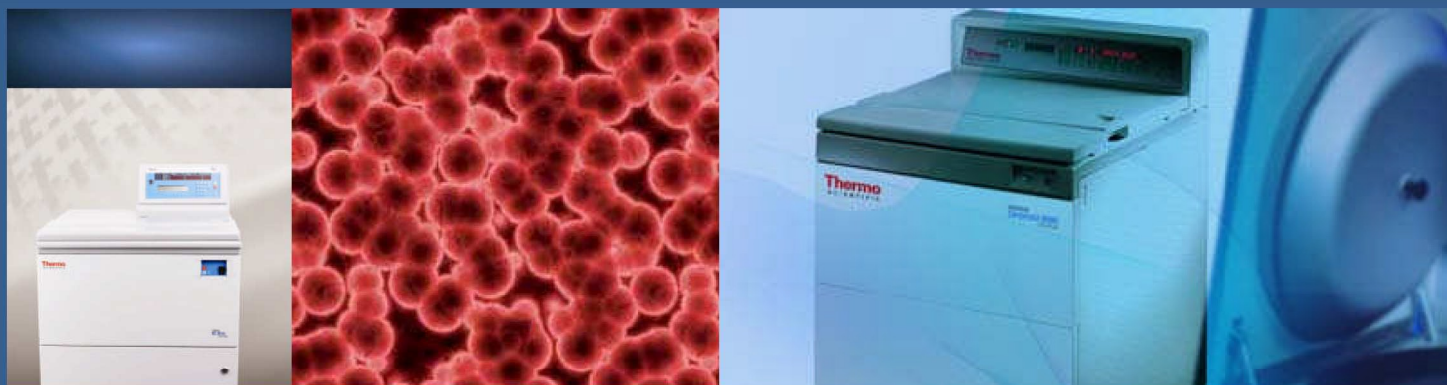

The spare parts list and electrical diagrams in this manual are valid for all RC 12BP+ and RC Bios. They are valid for Cryofuges and RC 3BP+ produced November 2010 and later (facelift). Refer to page 0-1!

The original version of this manual is valid.
Thermo Scientific cannot guarantee the accuracy
or completeness of subsequent copies



Spare Parts List

rev. 02

RC 3BP+, RC 12BP+
RC Bios
Cryofuge 6000i / 8500i
Rotors





Overview - Übersicht

<u>1000</u>	-	<u>Preventive maintenance kit</u>	<u>Wartungskit</u>
<u>1500</u>	-	<u>Seals, Gaskets</u>	<u>Dichtungen</u>
<u>2000</u>	-	<u>Main electronics</u>	<u>Hauptelektronik</u>
<u>3000</u>	-	<u>Drive unit</u>	<u>Antriebseinheit</u>
<u>4000</u>	-	<u>Brake resistor</u>	<u>Bremswiderstand</u>
<u>5000</u>	-	<u>Door latch</u>	<u>Deckelschloss</u>
<u>6000</u>	-	<u>Keys and indication</u>	<u>Tasten und Anzeige</u>
<u>7000</u>	-	<u>Imbalance switch</u>	<u>Unwuchtschalter</u>
<u>8000</u>	-	<u>Fan for electronics</u>	<u>Lüfter für Elektronik</u>
<u>9000</u>	-	<u>Cooling aggregate</u>	<u>Kälteanlage</u>
<u>10000</u>	-	<u>Chamber door</u>	<u>Kammerdeckel</u>
<u>11000</u>	-	<u>Key foils</u>	<u>Tasterfolien</u>
<u>12000</u>	-	<u>Tools</u>	<u>Werkzeuge</u>
		<u>H-6000, HBB-6, HLR-6</u>	
		<u>H-12000</u>	
		<u>75006606</u>	
		<u>F8-6x1000y</u>	

Outside view - Aussenansicht







Spare Parts - Ersatzteile

Pos	Component	Description	Beschreibung	RC 3BP+	RC 12BP+	RC Bios	Cryofuge	Image (not to scale) Bild (nicht Maßstabsgerecht)
1000	70907241	Preventive Maintenance Kit	Wartungskit	X	X	X	X	
	70907241	Incl. 3 anti vibration mounts	Inkl. 3 Gummipuffer	X	X	X	X	
	70907241	Incl. 6 sand paper discs	Inkl. 6 Sandpapierscheiben	X	X	X	X	
	70907241	Incl. 1 rubber flange	Inkl. 1 Gummiflansch	X	X	X	X	
	70907241	Incl. 1 felt packing	Inkl. 1 Filzring	X	X	X	X	
	70907241	Incl. 6 screws	Inkl. 6 Schrauben	X	X	X	X	
	70907241	Incl. 6 spacers	Inkl. 6 Distanzrohre	X	X	X	X	
1500	20056252	Chamber seal (2.3m)	Kesseldichtung (2,3m)	X	X	X	X	
1510	20290644	Seal door, foamed rubber (by meter!)	Moosgummidichtung (in Meter!)	X	X	X	X	
2000	70907375	Main board (without EEPROM and NV-RAM) CAUTION: Use only rev. 08 or higher! See next page for EEPROM and NV-RAM.	Hauptplatte (ohne EEPROM und NV-RAM) ACHTUNG: Nur Ver. 08 oder höher benutzen! Siehe nächste Seite für EEPROM und NV-RAM.	X	X	X	X	









Spare Parts - Ersatzteile

Pos	Component	Description	Beschreibung	RC 3BP+	RC 12BP+	RC Bios	Cryofuge	Image (not to scale) Bild (nicht Maßstabsgerecht)
2100	70907319	Software kit - RC 3BP+	Software kit - RC 3BP+	X				
2110	70907320	Software kit - RC 12BP+	Software kit - RC 12BP+		X			
2120	70907321	Software kit - RC Bios	Software kit - RC Bios			X		
2130	70907322	Software kit - Cryofuge 6000i	Software kit - Cryofuge 6000i				X	
2140	70907323	Software kit - Cryofuge 8500i	Software kit - Cryofuge 8500i				X	











Spare Parts - Ersatzteile

Pos	Component	Description	Beschreibung	RC 3BP+	RC 12BP+	RC Bios	Cryofuge	Image (not to scale) Bild (nicht Maßstabsgerecht)
2200	20150298	PCB Line filter	Leiterplatte Netzfilter	X	X	X	X	
2300	20170358	Line filter (mains input)	Netzfilter (Netzeingang)	X	X	X	X	
2400	20230221	Breaker 6A-K	Sicherungsautomat 6A-K	X	X	X	X	
2410	20230229	Breaker 25A-K	Sicherungsautomat 25A-K	X	X	X	X	
2500	See page 7	Contactator	Schütz	X	X	X	X	
2510	20540318	RC combination - 2x0,22µF + 220R	RC-Glied - 2x0,22µF + 220R	X	X	X	X	
2600	20110261	Operating hour counter 50Hz	Betriebsstundenzähler 50Hz	X	X	X	X	
2601	20110278	Operating hour counter 60Hz	Betriebsstundenzähler 60Hz	X	X	X	X	







Spare Parts - Ersatzteile

Pos	Component	Description	Beschreibung	RC 3BP+	RC 12BP+	RC Bios	Cryofuge	Image (not to scale) Bild (nicht Maßstabgerecht)
3000	20210428	Motor - RC3BP+, RC12BP+	Motor - RC3BP+, RC12BP+	X	X			
3001	20058650	Drive adapter (for H-12000 rotor)	Motoradapter (für H-12000 rotor)		X			
3010	20210327	Motor - Cryofuge 6000i/8500i	Motor - Cryofuge 6000i/8500i				X	
3020	20151102	PCB speed detection (not for RC Bios)	Drehzahlerfassungsplatine (nicht für RC Bios)	X	X		X	
3100	20210449	Motor - RC Bios only	Motor - nur RC Bios			X		
3110	70061637	Drive adapter (cone) for F8-6x1000y	Motoradapter (Konus) für F8-6x1000y			X		
3120	20059365	Clamping nut (for adapter)	Spannmutter (für Adapter)			X		
3130	20150291	PCB speed + imbal detect. (only for RC Bios)	Drehzahl + Unwuchterk. (nur für RC Bios)			X		







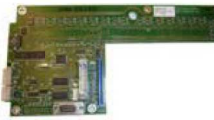

Spare Parts - Ersatzteile

Pos	Component	Description	Beschreibung	RC 3BP+	RC 12BP+	RC Bios	Cryofuge	Image (not to scale) Bild (nicht Maßstabsgerecht)
3200	70907241	Anti vibration mounts (PM kit)	Gummipuffer (Wartungskit)	X	X	X	X	
3210	70054606	Base plate for anti vibration mounts	Grundplatte für Gummipuffer	X	X	X	X	
4000	20160747	Brake resistor	Bremswiderstand	X	X	X	X	
5000	70904717	Door latch	Deckelschloss	X	X	X	X	



Spare Parts - Ersatzteile

Pos	Component	Description	Beschreibung	RC 3BP+	RC 12BP+	RC Bios	Cryofuge	Image (not to scale) Bild (nicht Maßstabsgerecht)
6000	20150271	PCB Keys and indication (RC)	Leiterplatte Tasten und Anzeige (RC)	X	X	X		
6010	20120350	LCD Display	LCD Anzeige	X	X	X		
6100	20151177	PCB Keys and indication (CF)	Leiterplatte Tasten und Anzeige (CF)				X	
6200	20180601	Key switch	Schlüsselschalter	X	X	X	X	
6300	20058653	Key foil (front buttons)	Tasterfolie (Frontbedienung)	X	X	X	X	
6400	20180759	Power switch	Netzschalter	X	X	X	X	









Spare Parts - Ersatzteile

Pos	Component	Description	Beschreibung	RC 3BP+	RC 12BP+	RC Bios	Cryofuge	Image (not to scale) Bild (nicht Maßstabgerecht)
7000	20180447	Micro switch (imbalance switch)	Mikroschalter (Unwuchterkennung)	X	X	X	X	
7010	20180446	Lever for imbalance switch	Rollenbetätiger für Unwuchtschalter	X	X	X	X	
8000	20210431	Fan 50Hz (for power electronics)	Lüfter 50Hz (für Leistungselektronik)	X	X	X	X	
8001	20210442	Fan 60Hz (for power electronics)	Lüfter 60Hz (für Leistungselektronik)	X	X	X	X	









Spare Parts - Ersatzteile

Evaporator part number = 70907259

Pos	Component	Description	Beschreibung	RC 3BP+	RC 12BP+	RC Bios	Cryofuge	Image (not to scale) Bild (nicht Maßstabgerecht)
9000	20140632	Temperature probe PT100	Temperaturfühler PT100	X	X	X	X	
9100	20240396	Collector	Sammler	X	X	X	X	
9200	20240487	Dryer-viewport-combination	Trockner-Schauglas- Kombination	X	X	X	X	
9300	20240356	Condenser	Verflüssiger	X	X	X	X	
9400	20210447	Fan (for condenser)	Lüfter (für Verflüssiger)	X	X	X	X	
9500	20052555	Rubber mount (for fan)	Gummipuffer (für Lüfter)	X	X	X	X	
9510	20480301	Sand paper disc (for rubber mount)	Sandpapierscheibe (für Gummipuffer)	X	X	X	X	











Spare Parts - Ersatzteile

Model	Version	Compressor / Verdichter	Contactora / Schütz	Over-current trip / Überstromauslöser	Expansion valve / Expansionsventil	Nozzle for ex. valve / Düse für Ex. ventil	Pressure switch / Druckwächter	Heat exchanger / Wärmetauscher
RC 3BP+	7530	20240579	20110304	20110323	20240485	20240422	50053868	20240401
	7533	20240482	20110304	20110323	20240485	20240422	50053868	20240401
	7565	20240533	20110262	20110322	20240485	20240421	20240578	20240398
RC 12BP+	7030	20240579	20110304	20110323	20240488	20240491	20240578	20240401
	7031	20240579	20110304	20110323	20240488	20240491	20240578	20240401
	7032	20240661	20110304	20110318	20240488	20240491	20240578	20240398
	7033	20240533	20110262	20110318	20240485	20240421	20240578	20240398
RC Bios	7034	20240579	20110304	20110323	20240488	20240491	20240578	20240401
	7035	20240579	20110304	20110323	20240488	20240491	20240578	20240401
	7036	20240661	20110304	20110318	20240488	20240491	20240578	20240398
	7037	20240533	20110262	20110318	20240485	20240421	20240578	20240398
CF 6000i	7520	20240533	20110262	20110322	20240485	20240421	20240578	20240398
	7571	20240595	20110304	20110322	20240485	20240421	20240578	20240398
	7526	20240482	20110262	20110322	20240485	20240421	70907509	20240401
CF 8500i	7550	20240579	20110262	20110322	20240485	20240421	20240578	20240398
	7551	20240595	20110304	20110322	20240485	20240421	20240578	20240398
<p>These images are for your reference only and do not show all variants! Diese Bilder dienen nur der Veranschaulichung und stellen nicht alle Varianten dar!</p>								







Spare Parts - Ersatzteile

Pos	Component	Description	Beschreibung	RC 3BP+	RC 12BP+	RC Bios	Cryofuge	Image (not to scale) Bild (nicht Maßstabsgerecht)
10000	70056239	Chamber door	Zentrifugendeckel	X	X	X	X	
10010	20290644	Door seal, foamed rubber (order by meter!)	Moosgummidichtung (in Meter!)	X	X	X	X	
10020	70056677	Door handle	Türgriff	X	X	X	X	
10030	70054536	Hinge	Scharnier	X	X	X	X	
10040	20051304	View port	Sichtfenster	X	X	X	X	
10050	20056595	Hook	Kloben	X	X	X	X	
10100	20310244	Gas lid stay	Gasdruckfeder	X	X	X	X	
10110	70049061	Holder (for gas lid stay)	Lagerbock (für Gasdruckfeder)	X	X	X	X	
10200	70904717	Door latch	Deckelschloss	X	X	X	X	









Spare Parts - Ersatzteile

Pos	Component	Description	Beschreibung	RC 3BP+	RC 12BP+	RC Bios	Cryofuge	Image (not to scale) Bild (nicht Maßstabgerecht)
11000	20900504	Key foil - RC 3BP+	Tasterfolie - RC 3BP+	X				
11010	20900515	Key foil - RC 12BP+	Tasterfolie - RC 12BP+		X			
11020	20900516	Key foil - RC Bios	Tasterfolie - RC Bios			X		
11030	20907120	Key foil - Cryofuge	Tasterfolie - Cryofuge				X	



Spare Parts - Ersatzteile

Pos	Component	Description	Beschreibung	RC 3BP+	RC 12BP+	RC Bios	Cryofuge	Image (not to scale) Bild (nicht Maßstabsgerecht)
12000	20310260	Door key	Schlüssel	X	X	X	X	
12010	20360001	Wrench 8mm ,10mm	Maulschlüssel 8mm, 10mm	X	X	X	X	
12020	20034416	Wrench 17mm, 19mm	Maulschlüssel 17mm, 19mm	X	X	X	X	
12030	20360008	Wrench 24mm	Maulschlüssel 24mm	X	X	X	X	
12040	20005492	Box spanner 10mm	Steckschlüssel 10mm				X	
12050	20280119	Spirit level	Dosenlibelle	X	X	X	X	
12060	20907075	Foot (4 needed per unit)	Gerätefuß (4 pro Gerät benötigt)	X	X	X	X	
12100	70907249	Tool kit (incl. 12000 – 12030 & 12050 – 12060)	Werkzeugset (incl. 12000 – 12030 & 12050 – 12060)	X	X	X		
12200	70907577	Tool kit (incl. 12000 – 12060)	Werkzeugset (incl. 12000 – 12060)				X	



Spare Parts - Ersatzteile - H-6000A, HBB-6, HLR-6

Pos	Component	Description
-	11237	Rotor cover assembly (incl. 1, 4, 5, 7, 8)
1	11232	Cover
2	44040	H-6000A bucket (set of 6)
2	11754	HBB-6 bucket (set of 6)
2	11351	HLR-6 bucket (set of 6)
3	11235	Rotor drive adapter
4	67483	Retaining ring
5	11009	Speed decal
6	11238	Locking stud
7	11272	Cover knob
8	11227	Nylon washer
9	61835	Cap screw, #10-32 x 5/8 long
-	11445	Rotor extractor
-	11776	Bucket cover for H-6000A
-	11273	Windshield replacement kit

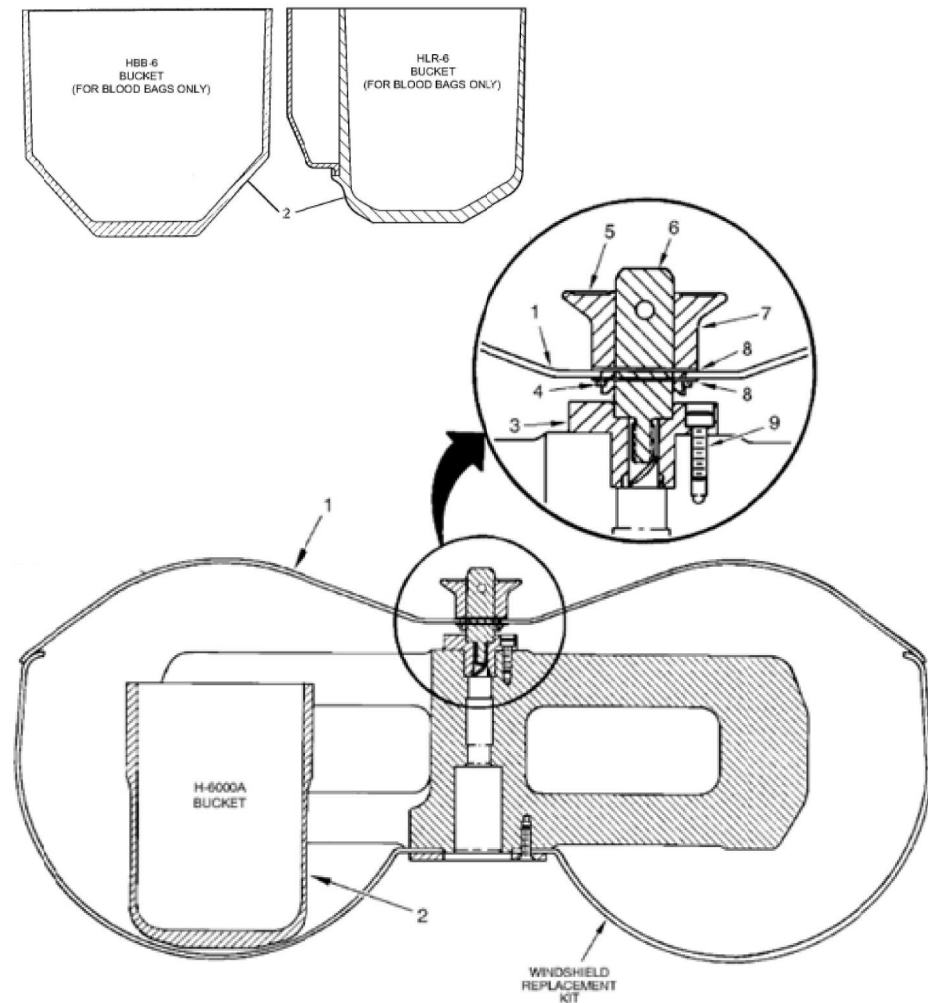

Spare Parts - Ersatzteile - H-12000

Pos	Component	Description
1	77038	Cover assembly (incl. 4, 5, 6, 7, 8)
2	77021	Rotor buckets (pair)
3	11235	Drive adapter
4	67483	Retaining ring
5	11009	Speed decal
6	11238	Locking stud
7	11070	Cover knob
8	11227	Nylon washer
9	61835	Cap screw, SST, #10-32 x 5/8 inch long
10	77048	Windshield (balanced assembly with hub)
-	70060606	Apron for blood processing

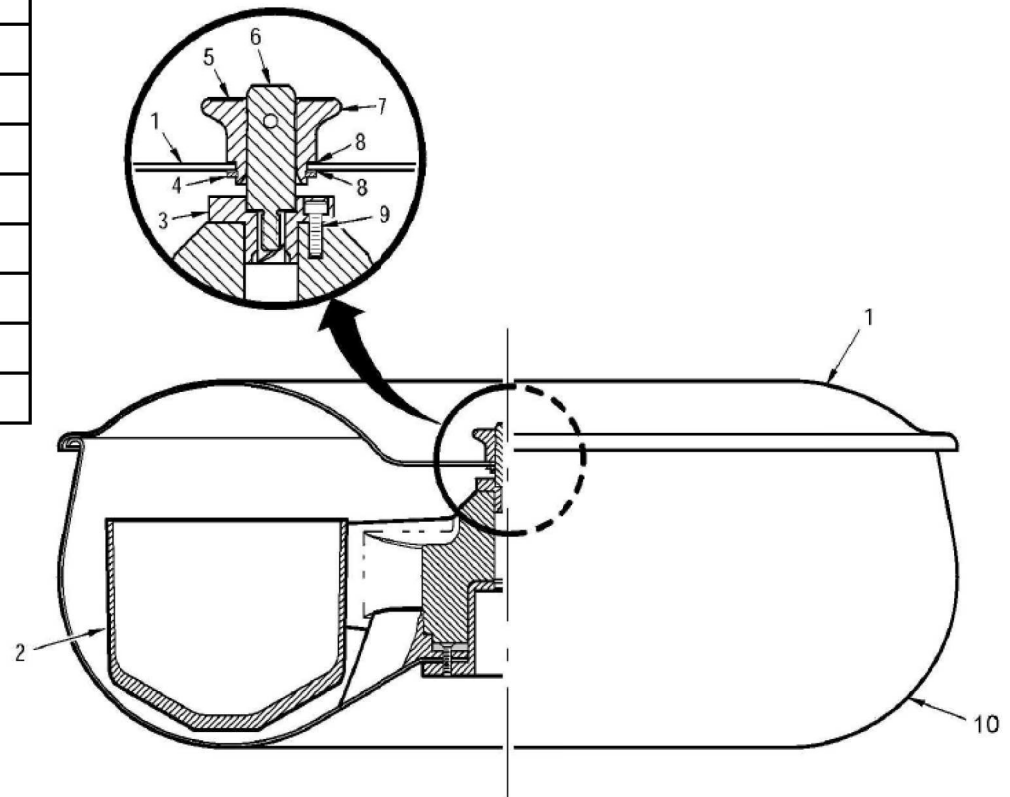

Spare Parts - Ersatzteile - 75006606

Pos	Component	Description
1	75007614	Lid assembly (incl. 2 & 3)
2	20310246	Knob
3	20031694	Washer

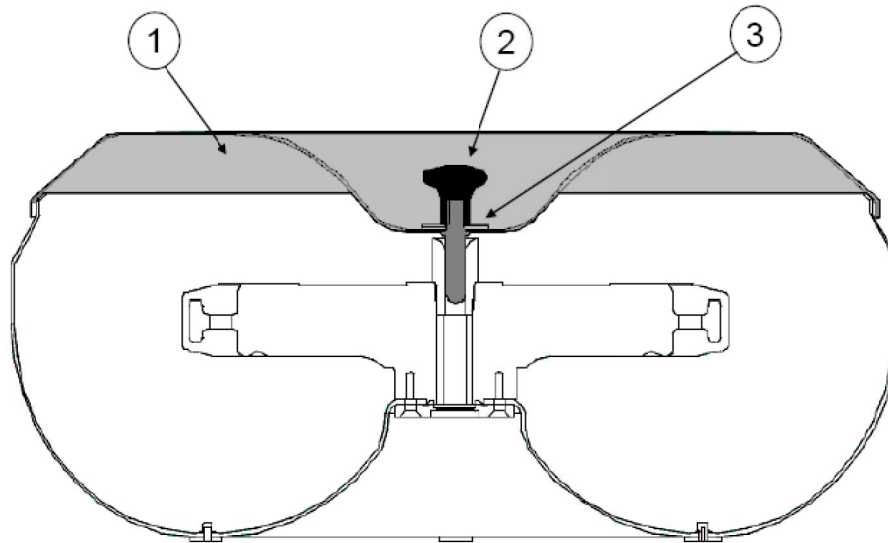

Spare Parts - Ersatzteile - F8-6x1000y

Pos	Component	Description
1	021-061137	Refresher Kit
2	022-061137	Lid Oring package
3	099-061137	Lid Assembly

