



Thermo Scientific

# **Heraeus Multifuge X3 F Heraeus Multifuge X3 FR**

## **Instruction manual**

50117505-4

October 2016

© 2011 Thermo Fisher Scientific Inc. All rights reserved.

BIOLiner™, BIOShield™, HIGHPlate™, HIGHConic™, AutoLock™ FIBERLite™ and CLINIConic™ are either registered trademarks or trademarks of Thermo Fisher Scientific.

All other trademarks are the property of Thermo Fisher Scientific Inc. and its subsidiaries.

Thermo Electron LED GmbH  
Zweigniederlassung Osterode  
Am Kalkberg  
37520 Osterode am Harz  
Germany

Thermo Fisher Scientific Inc. provides this document to its customers with a product purchase to use in the product operation. This document is copyright protected and any reproduction of the whole or any part of this document is strictly prohibited, except with the written authorization of Thermo Fisher Scientific Inc.

The contents of this document are subject to change without notice. All technical information in this document is for reference purposes only. System configurations and specifications in this document supersede all previous information received by the purchaser.

**Thermo Fisher Scientific Inc. makes no representations that this document is complete, accurate or errorfree and assumes no responsibility and will not be liable for any errors, omissions, damage or loss that might result from any use of this document, even if the information in the document is followed properly.**

This document is not part of any sales contract between Thermo Fisher Scientific Inc. and a purchaser. This document shall in no way govern or modify any Terms and Conditions of Sale, which Terms and Conditions of Sale shall govern all conflicting information between the two documents.

Original instruction manual 50117505-4 printed in October 2016.



**KONFORMITÄTSERKLÄRUNG  
DECLARATION OF CONFORMITY**

Name und Anschrift des Herstellers und des Bevollmächtigten für die Zusammenstellung der relevanten technischen Unterlagen:  
*Name and address of the manufacturer and of the authorized representative to compile the relevant technical documentation:*

**Thermo Electron LED GmbH  
Zweigniederlassung Osterode  
Am Kalkberg  
37520 Osterode am Harz  
Germany**

Gegenstand der Erklärung / *Object of the declaration:*

<b>Beschreibung /description</b>	<b>: Zentrifuge mit Zubehör / Centrifuge with accessories</b>
<b>Marke / brand</b>	<b>: Thermo Scientific</b>
<b>Modellbezeichnung / model name</b>	<b>: Heraeus Multifuge X3 F , Heraeus Multifuge X3 FR</b>
<b>Modell Nr. / model no.</b>	<b>: 75004530 , 75004536</b>
<b>Gültig ab Equipmentnr. Valid from equipment no.</b>	<b>: 42029980</b>

mit allen einschlägigen Bestimmungen der Richtlinie über In-vitro-Diagnostika 98/79/EG in Übereinstimmung ist.  
*is in conformity with all relevant terms of directive for in vitro diagnostic medical devices 98/79/EC.*

Die Maschine ist auch in Übereinstimmung mit den Schutzziele der Maschinenrichtlinie 2006/42/EG, der Niederspannungsrichtlinie 2014/35/EU und der Richtlinie 2014/30/EU über elektromagnetische Verträglichkeit.  
*The machinery is in accordance with the protection goals for the directives machinery 2006/42/EC, low voltage 2014/35/EU and electromagnetic compatibility 2014/30/EC.*

*Der oben beschriebene Gegenstand der Erklärung erfüllt auch die Vorschriften der Richtlinie 2011/65/EU des Europäischen Parlaments und des Rates vom 8. Juni 2011 zur Beschränkung der Verwendung bestimmter gefährlicher Stoffe in Elektro- und Elektronikgeräten. Die alleinige Verantwortung für die Ausstellung dieser Konformitätserklärung trägt der Hersteller.*

*The object of the declaration described above is also in conformity with Directive 2011/65/EU of the European Parliament and of the Council of 8 June 2011 on the restriction of the use of certain hazardous substances in electrical and electronic equipment.*

*This declaration of conformity is issued under the sole responsibility of the manufacturer.*

Angewandte Normen/  
Standards used:

**EN 61010-1: 2004  
EN 61010-2-020: 2006  
EN 61010-2-101: 2002  
EN 61326-1: 2013  
EN 61326-2-6: 2013**

Unterzeichnet für und im Namen von: Thermo Electron LED GmbH.  
*Signed for and on behalf of: Thermo Electron LED GmbH*

Osterode am Harz, den 21.10.2016

Dr. Andreas Karl,  
Director R&D Global Project Management

	Name	Datum	Dokument	Revision
Freigegeben	Abdullah Laaboubi	18.10.2016	50119473	05

## WEEE Conformity

This product is subject to the regulations of the EU Waste Electrical & Electronic Equipment (WEEE) Directive 2002/96. It is marked by the following symbol:



Thermo Fisher Scientific has entered into agreements with recycling and disposal companies in all EU Member States for the recycling and disposal of this device. For information on recycling and disposal companies in Germany and on the products of Thermo Fisher Scientific, which fall under the RoHS Directive (Restriction of the use of certain hazardous substances in electrical and electronic equipment), please visit the website [www.thermo.com/WEEERoHS](http://www.thermo.com/WEEERoHS)

# Table of Contents

	<b>Preface</b> .....	<b>iii</b>
	<b>Scope of Supply</b> .....	<b>iii</b>
	<b>Intended Use</b> .....	<b>iii</b>
	<b>Accident Prevention</b> .....	<b>iv</b>
	<b>Precautions</b> .....	<b>iv</b>
<b>Chapter 1</b>	<b>Introduction and Description</b> .....	<b>1-1</b>
	Characteristics of the Heraeus Multifuge X3 F / X3 FR .....	1-2
	Technical Data .....	1-3
	Directives, Standards and Guidelines .....	1-4
	Functions and Features .....	1-5
	Mains Supply .....	1-5
	Rotor Selection .....	1-6
<b>Chapter 2</b>	<b>Before use</b> .....	<b>2-1</b>
	Before Setting up .....	2-2
	Setting up .....	2-2
	Transporting the Centrifuge .....	2-4
	Location .....	2-4
	Aligning the Centrifuge .....	2-4
	Mains Connection .....	2-5
	Storage .....	2-6
<b>Chapter 3</b>	<b>Control Panel</b> .....	<b>3-1</b>
	Control Panel .....	3-2
	Keys .....	3-2
<b>Chapter 4</b>	<b>Operation</b> .....	<b>4-1</b>
	Switch on Centrifuge .....	4-2
	Lid Opening .....	4-2
	Close Lid .....	4-2
	Rotor Installation .....	4-2
	Entering Parameters .....	4-4
	Centrifugation .....	4-10
	Temperature Adaptation during Standstill .....	4-11
	Short-term Centrifugation .....	4-11
	Removing the Rotor .....	4-12
	Aerosol-tight Rotors .....	4-12
	Aligning the Centrifuge .....	4-13

<b>Chapter 5</b>	<b>System Menu .....</b>	<b>5-1</b>
	Description .....	5-2
<b>Chapter 6</b>	<b>Maintenance and Care .....</b>	<b>6-1</b>
	Cleaning Intervals .....	6-2
	Cleaning .....	6-2
	Disinfection .....	6-3
	Decontamination .....	6-4
	Autoclaving .....	6-5
	Service of Thermo Fisher Scientific .....	6-5
<b>Chapter 7</b>	<b>Trouble Shooting .....</b>	<b>7-1</b>
	Mechanical Emergency Door Release .....	7-2
	Troubleshooting by User .....	7-3
	When to contact Customer Service .....	7-5
	<b>Chemical Compatibility Chart .....</b>	<b>A-1</b>
	<b>Contact Information .....</b>	<b>B-1</b>

## Preface

Before starting to use the centrifuge, read through this instruction manual carefully and follow the instructions.

The information contained in this instruction manual is the property of Thermo Fisher Scientific; it is forbidden to copy or pass on this information without explicit approval.

Failure to follow the instructions and safety information in this instruction manual will result in the expiration of the sellers warranty.

## Scope of Supply

Article Number		Quantity	Check
	Centrifuge Heraeus Multifuge X3 F	1	<input type="checkbox"/>
	Power supply cable	1	<input type="checkbox"/>
50117505	Instruction manual	1	<input type="checkbox"/>
70009824	Anti-corrosion oil	1	<input type="checkbox"/>

If any parts are missing, please contact your nearest Thermo Fisher Scientific representative.

## Intended Use

- This centrifuge is an IVD accessory, and therefore subject to the Directive 98/79/EC of the European Parliament and the Council of October 27, 1998 on in vitro diagnostic medical devices.
- This centrifuge is a laboratory product designed to separate components by generation of Relative Centrifugal Force. It separates human samples (e.g. blood, urine and other body fluids) collected in appropriate containers, either alone or after addition of reagents or other additives.
- As general-purpose centrifuge, it is designed to also run other containers filled with chemicals, environmental samples and other non-human body samples.
- This centrifuge should be operated by trained specialists only.

# Accident Prevention

Prerequisite for the safe operation of the Heraeus Multifuge X3 F / X3 FR is a work environment in compliance with standards, directives and trade association safety regulations and proper instruction of the user.

The safety regulations contain the following basic recommendations:

- Maintain a radius of at least 30 cm around the centrifuge.
- Implementation of special measures which ensure that no one can approach the centrifuge for longer than absolutely necessary while it is running.
- The mains plug must be freely accessible at all times. Pull out the power supply plug or disconnect the power supply in an emergency.

## Precautions

In order to ensure safe operation of the Heraeus Multifuge X3 F / X3 FR, the following general safety regulations must be followed:

- The centrifuge should be operated by trained specialists only.
- The centrifuge is to be used for its intended use only.
- Plug the centrifuge only into sockets which have been properly grounded.
- Do not move the centrifuge while it is running.
- Do not lean on the centrifuge.
- Use only rotors and accessories for this centrifuge which have been approved by Thermo Fisher Scientific. Exceptions to this rule are commercially available glass or plastic centrifuge tubes, provided they have been approved for the speed or the RCF value of the rotor.
- Do not use rotors which show any signs of corrosion and/or cracks.
- Do not touch the mechanical components of the rotor and do not make any changes to the mechanical components.
- Use only with rotors which have been properly installed. Follow the instructions on the Autolock in section “[Rotor Installation](#)” on [page 4-2](#).
- Use only with rotors which have been loaded properly. Follow the instructions given in the rotor manual.
- Never overload the rotor. Follow the instructions given in the rotor manual.
- Never start the centrifuge when the lid is open.
- Never open the lid until the rotor has come to a complete stop and this has been confirmed in the display.



- The lid emergency release may be used in emergencies only to recover the samples from the centrifuge, e.g. during a power failure (see section “[Mechanical Emergency Door Release](#)” on [page 7-2](#)).
- Never use the centrifuge if parts of its cover panels are damaged or missing.
- Do not touch the electronic components of the centrifuge or alter any electronic or mechanical components.
- Please observe the safety instructions.

Please pay particular attention to the following aspects:

- Location: well-ventilated environment, set-up on a level and rigid surface with adequate load-bearing capacity.
- Rotor installation: make sure the rotor is locked properly into place before operating the centrifuge.
- Especially when working with corrosive samples (salt solutions, acids, bases), the accessory parts and vessel have to be cleaned carefully.
- Always balance the samples.

Centrifuging hazardous substances:

- Do not centrifuge explosive or flammable materials or substances which could react violently with one another.
- The centrifuge is neither inert nor protected against explosion. Never use the centrifuge in an explosion-prone environment.
- Do not centrifuge inflammable substances.
- Do not centrifuge toxic or radioactive materials or any pathogenic micro-organisms without suitable safety precautions.

When centrifuging microbiological samples from the Risk Group II (according to the Bio-safety Manual" of the World Health Organization WHO), aerosol-tight biological seals have to be used.

For materials in a higher risk group, extra safety measures have to be taken.

- If toxins or pathogenic substances have gotten into the centrifuge or its parts, appropriate disinfection measures have to be taken (see “[Disinfection](#)” on [page 6-3](#)).
- Highly corrosive substances which can cause material damage and impair the mechanical stability of the rotor, should only be centrifuged in corresponding protective tubes.

IF A HAZARDOUS SITUATION OCCURS, TURN OFF THE POWER SUPPLY TO THE CENTRIFUGE AND LEAVE THE AREA IMMEDIATELY.

### Intended Use

The centrifuge is to be used for separating materials of different density or particle size suspended in a liquid.

Maximum sample density at maximum speed:  $1,2 \frac{g}{cm^3}$



This symbol refers to general hazards.

CAUTION means that material damage could occur.

WARNING means that injuries or material damage or contamination could occur.



This symbol refers to biological hazards.

Observe the information contained in the instruction manual to keep yourself and your environment safe.

# Introduction and Description

## Contents

- “Characteristics of the Heraeus Multifuge X3 F / X3 FR” on page 1-2
- “Technical Data” on page 1-3
- “Directives, Standards and Guidelines” on page 1-4
- “Functions and Features” on page 1-5
- “Mains Supply” on page 1-5
- “Rotor Selection” on page 1-6

# Characteristics of the Heraeus Multifuge X3 F / X3 FR

The Heraeus Multifuge X3 F / X3 FR is an in-vitro diagnostics device according to the In-Vitro Diagnostics Directive 98/79/EC.

Several rotors with a wide range of tubes can be used.

The set speed is reached within seconds. The maintenance-free induction motor ensures quiet and low-vibration operation even at high speeds, and guarantees a very long lifetime.

The user-friendly control panel makes it easy to pre-set the speed, RCF value, running time, temperature, and running profile (acceleration and braking curves). You can choose between the display of speed and RCF or the entry mode.

These settings can be changed even while the centrifuge is running.

With the help of the PULSE key , you can also centrifuge a sample for just a few seconds, if called for.

The Heraeus Multifuge X3 F / X3 FR is equipped with various safety features:

- The housing and rotor chamber consist of steel plate, the interior of armour steel, while the front panel is made of high-impact resistant plastic.
- The lid is equipped with a view port and a lock.
- The lid of the centrifuge can only be opened while the centrifuge is switched on and the rotor has come to a complete stop. The centrifuge cannot be started until the lid has been closed properly.
- The integrated rotor detection systems ensures that no inadmissible speed settings can be preselected.
- Electronic imbalance recognition
- Lid emergency release: For emergencies only, e.g. during power failures (see “[Mechanical Emergency Door Release](#)” on [page 7-2](#))

## Technical Data

The technical data of the Heraeus Multifuge X3 F / X3 FR is listed in the following table.

**Table 1-1.** Technical Data Heraeus Multifuge X3 F / X3 FR

Feature	Value			
Environmental conditions	-Use in interior spaces -Altitudes of up to 2,000 m above sea level -max. relative humidity 80% up to 31 °C; decreasing linearly up to 50% relative humidity at 40 °C.			
permissible ambient temperature	+2 °C to +35 °C		+2 °C to +35 °C	
Overvoltage category	II		II	
Pollution degree	2		2	
Heat dissipation	ventilated		refrigerated	
	230V	120V	230V	120V
	6653 BTU/h	4776 BTU/h	5800 BTU/h	4776 BTU/h
IP	20		20	
running time	unlimited		unlimited	
max Speed $n_{max}$	15200 rpm (depending on the rotor)		15200 rpm (depending on the rotor)	
min Speed $n_{min}$	300 rpm		300 rpm	
maximum RCF value at $n_{max}$	25314 x g		25314 x g	
maximum kinetic energy	< 62.5 kJ		< 62.5 kJ	
noise level at maximum speed	< 64 dB (A)		< 64 dB (A)	
temperature setting range	-10 °C to +40 °C			
Dimensions	ventilated		refrigerated	
	Height	840 mm	840 mm	
	Width	550 mm	550 mm	
	Depth	670 mm	670 mm	
	Table top height	790 mm	790 mm	
weight without rotor	152.5 kg		142.5 kg	

## Directives, Standards and Guidelines

**Table 1-2.** Directives, Standards and Guidelines

Tension / Frequency		Produced and inspected according to the following standards and guidelines
230V 50/60Hz	2006/95/EC Low Voltage Directive: 2006/42/EC & 98/37/EC Machine Directive: 2004/108/EC EMC Directive 98/79/EC In-vitro-Diagnostika (IvD)	EN 61010-1, 2 <sup>nd</sup> Edition EN 61010-2-020, 2 <sup>nd</sup> Edition EN 61010-2-101 EN 61326-1 EN 61326-2-6 EN 55011B EN 61000-6-2 EN ISO 13485
230V 60Hz		UL 61010-1, 2 <sup>nd</sup> Edition
120V 60Hz		CAN/CSA-C22.2 No. 61010-1, 2 <sup>nd</sup> Edition
100V 60Hz		IEC 61010-2-20, 2 <sup>nd</sup> Edition
		(Pollution degree 2, Overvoltage category II) IEC 61010-2-101 Emitted interference FCC Part 15 CLASS A
		NOTE: This equipment has been tested and found to comply with the limits for a Class A digital device, pursuant to Part 15 of the FCC Rules. These limits are designed to provide reasonable protection against harmful interference when the equipment is operated in a commercial environment. This equipment generates, uses, and can radiate radio frequency energy and, if not installed and used in accordance with the instruction manual, may cause harmful interference to radio communications. Operation of this equipment in a residential area is likely to cause harmful interference in which case the user will be required to correct the interference at his own expense.
100V 50Hz		IEC 61010-1 2 <sup>nd</sup> Edition IEC 61010-2-020 2 <sup>nd</sup> Edition IEC 61010-2-101 EN 61326-1 EN 61326-2-6 EN 55011A EN 61000-6-2 EN ISO 13485

## Functions and Features

The following table gives an overview of the important functional and performance characteristics of the Heraeus Multifuge X3 F / X3 FR.

**Table 1-3.** Functions and Features

Component / Function	Description / Features
Structure / Housing	Galvanized steel chassis with armoured plating
Chamber	Stainless steel / varnished steel
Drive	Induction drive without carbon brushes
Keys and display	Easy-to-clean keypad and display surface
Controls	Microprocessor-controlled
Internal memory	The most recent data is saved
Functions	RCF-selection, temperature control, pretemp with cooling equipped devices
Acceleration / braking profiles	9 acceleration and 10 braking curves
Rotor recognition	Automatic
Imbalance recognition	Electronic, contingent on rotor and speed
Lid lock	Automatic lid closing and locking starting from an initial hold position

## Mains Supply

The following table contains an overview of the electrical connection data for the Heraeus Multifuge X3 F / X3 FR. This data is to be taken into consideration when selecting the mains connection socket.

**Table 1-4.** Electrical connection data of the Heraeus Multifuge X3 F / X3 FR

Cat.		Mains voltage	Frequency	Rated current	Power consumption	Equipment fuse	Building fuse
7500 4536	refrigerated	230 V	50 / 60 Hz	10.5 A	1950 W	15 AT	16 AT
7500 4537	refrigerated	120 V	60 Hz	12 A	1400 W	15 AT	15 AT
7500 4530	ventilated	230 V	50 / 60 Hz	11 A	1700 W	15 AT	16 AT
7500 4531	ventilated	120 V	60 Hz	12 A	1400 W	15 AT	15 AT

## Rotor Selection

The Heraeus Multifuge X3 F / X3 FR is supplied without a rotor.

Various rotors are available to choose from.

TX-750	7500 3607
with round buckets	7500 3608
with rectangular buckets	7500 3614
incl. Microtiter carrier	7500 3617
incl. ABI-bucket	7500 3618
BIOshield™ 1000A	7500 3603
BIOLiner™	7500 3667
HIGHPlate™ 6000	7500 3606
<i>FIBERLite™</i> H3LV	7500 3665
<i>FIBERLite™</i> F14S-6 x 250 LE	7500 3662
<i>FIBERLite™</i> F15-6 x 100	7500 3698
<i>FIBERLite™</i> F13S-14 x 50c	7500 3661
<i>FIBERLite™</i> F15-8 x 50c	7500 3663
<i>FIBERLite™</i> F21-48 x 2	7500 3664
Microliter 48 x 2	7500 3602
HIGHConic™ 6 x 100	7500 3620
M-20	7500 3624

The technical data of the rotors and the corresponding adapters and reduction sleeves for various commercially available containers can be found in the corresponding rotor operating manuals.

For more information visit our website at: <http://www.thermo.com>



## Before use

### Contents

- “Before Setting up” on page 2-2
- “Transporting the Centrifuge” on page 2-4
- “Location” on page 2-4
- “Aligning the Centrifuge” on page 2-4
- “Mains Connection” on page 2-5
- “Storage” on page 2-6

## Before Setting up

1. Check the centrifuge and the packaging for any shipping damage.  
Inform the shipping company and Thermo Fisher Scientific immediately if any damage is discovered.
2. Remove the packaging.
3. Check the order for completeness (see “[Scope of Supply](#)” on [page iii](#)).  
If the order is incomplete, please contact Thermo Fisher Scientific.

## Setting up

1. Place the pallet with the centrifuge so that you have at least 1.5 m room in front of the pallet.

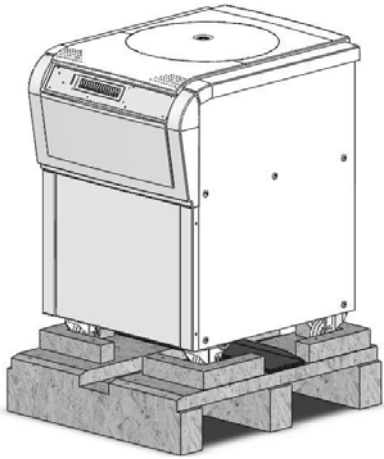

2. Release the rails from the pallet.

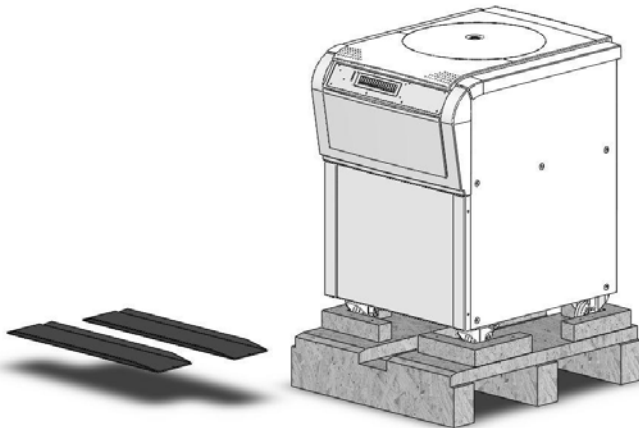

3. Screw the rails onto the pallet in front of the centrifuge.

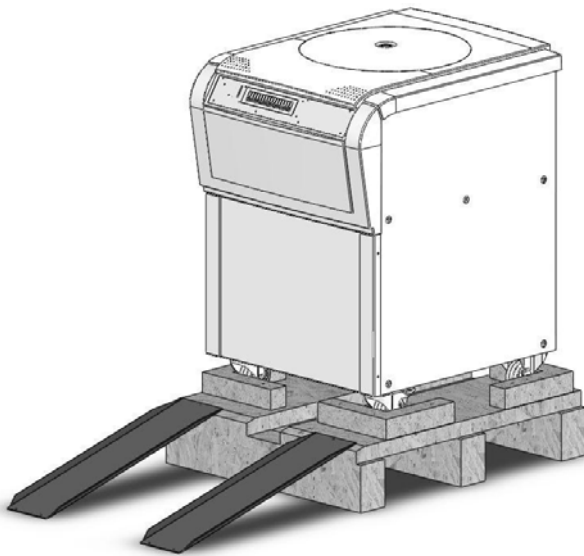

4. Remove the protectors that locate the centrifuge on the pallet. Release the castors. Use several people in order to roll the centrifuge off the pallet.

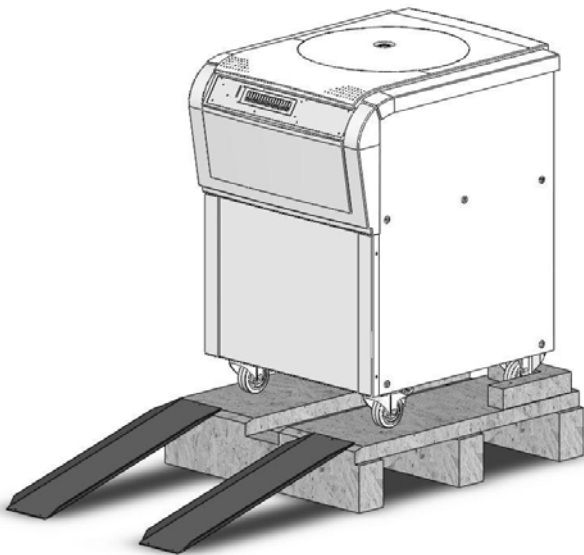

5. Fix the castors once the centrifuge is in its final position.

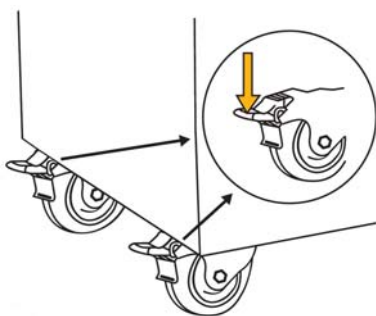



**CAUTION** Fix the castors.

## Transporting the Centrifuge

- Due to its weight (see “[Technical Data](#)” on [page 1-3](#)), the centrifuge should be carried by several people.
- The centrifuge can be damaged by impacts.
- Transport the centrifuge upright and if at all possible in its packaging.



**WARNING** Always remove the rotor before moving the centrifuge.

## Location

The centrifuge should only be operated indoors.

The set-up location must fulfil the following requirements:

- A safety zone of at least 30 cm must be maintained around the centrifuge. People and hazardous substances must be kept out of the safety zone while centrifuging.
- The supporting structure must be stable and free of resonance, for example a level laboratory bench.
- The supporting structure must be suitable for horizontal setup of the centrifuge.
- The centrifuge should not be exposed to heat and strong sunlight.



**WARNING** UV rays reduce the stability of plastics.  
Do not subject the centrifuge, rotors and plastic accessories to direct sunlight.

- The set-up location must be well-ventilated at all times.

## Aligning the Centrifuge

The horizontal alignment of the centrifuge must be checked every time after moving it to a different location.

The supporting structure must be suitable for horizontal setup of the centrifuge.



**CAUTION** If the centrifuge isn't level, imbalances can occur and the centrifuge can be damaged.  
Do not place anything under the feet to level the centrifuge.

## Mains Connection

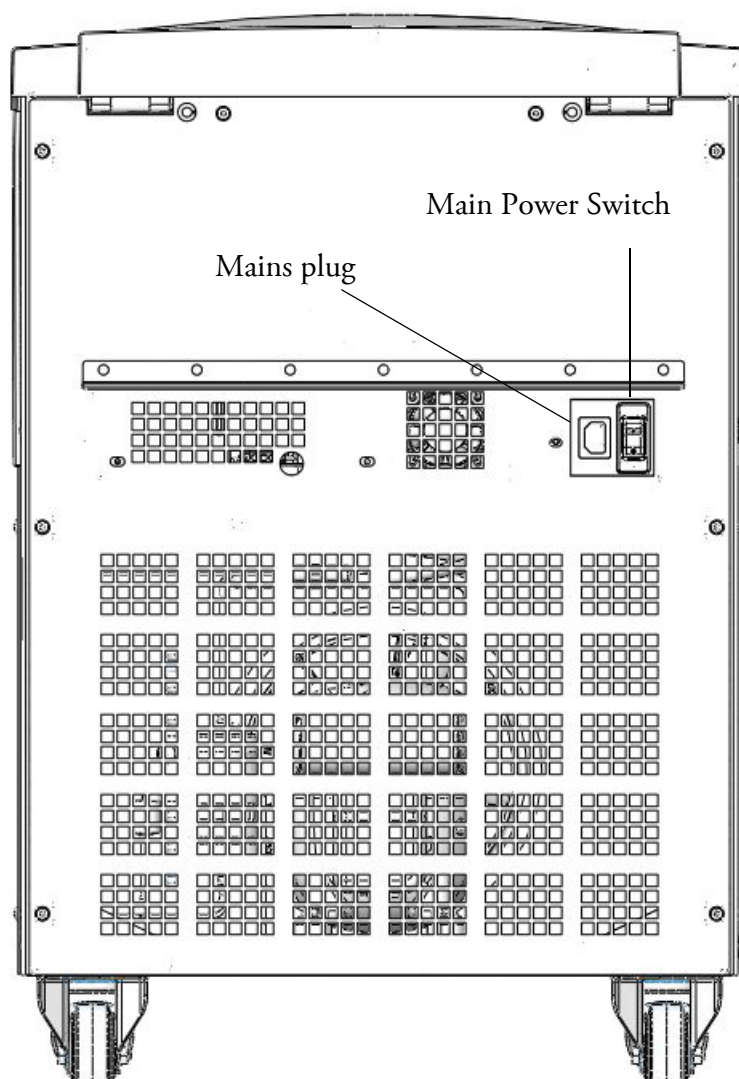

**Figure 2-1.** Mains Connection

1. Turn off the power supply switch on the back (press "0").
2. Plug the centrifuge into grounded electrical sockets only.
3. Check whether the cable complies with the safety standards of your country.
4. Make sure that the voltage and frequency correspond to the figures on the rating plate.
5. Establish the connection to the power supply with the connecting cable.

## **Storage**

- Before storing the centrifuge and the accessories it must be cleaned and if necessary disinfected and decontaminated.
- Store the centrifuge in a clean, dust-free location.
- Be sure to place the centrifuge on its feet.
- Avoid direct sunlight.
- Fix the castors.

# Control Panel

## Contents

- “Control Panel” on page 3-2
- “Keys” on page 3-2





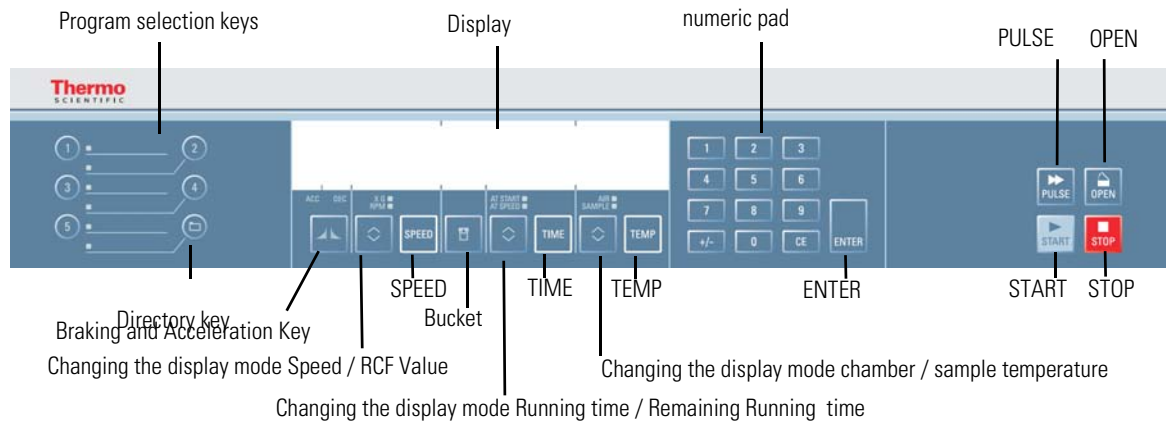







## Control Panel

The control panel contains the keys and displays of the centrifuge (only the power switch is located on the back of the device). All parameters can be selected and changed (during operation).



## Keys

The keys allow user intervention for controlling the operating mode as follows:

Key	Display contents
 <b>Start</b>	Normal start of the centrifuge
 <b>Stop</b>	End run manually
 <b>Open lid</b>	Automatic release (possible only when device is switched on). Emergency release (see <a href="#">"Mechanical Emergency Door Release"</a> on page 7-2)
 <b>Pulse</b>	By pressing the key PULSE  the centrifuge starts immediately and accelerates up to the end speed. Releasing the key initiates a stopping process at the highest braking curves.
 <b>Directory</b>	Use the directory key  in order to modify the displayed value
 <b>Bucket</b>	Use the bucket key  in order to have all available bucket types displayed in succession.
 <b>Braking and Acceleration Curves</b>	Use the ACC DEC key  to toggle between braking and acceleration curves.
 <b>Changing the display mode</b>	Use the Toggle key  to change the display mode. (speed / RCF value, sample / chamber temperature, run time counter from start or preset speed on)



# Operation

## Contents

- “Switch on Centrifuge” on page 4-2
- “Lid Opening” on page 4-2
- “Rotor Installation” on page 4-2
- “Entering Parameters” on page 4-4
- “Centrifugation” on page 4-10
- “Temperature Adaptation during Standstill” on page 4-11
- “Short-term Centrifugation” on page 4-11
- “Removing the Rotor” on page 4-12
- “Aligning the Centrifuge” on page 4-13

## Switch on Centrifuge

1. Turn on the power switch on the back of the device.  
The device performs a self-check of its software.
  - a. When the centrifuge lid is closed the following display shows:



The image shows a digital display with two lines. The top line displays '0' on the left and '0.00' on the right. The bottom line displays '9 9 15000' on the left, '20.30' in the middle, and '-10' on the right.

The top line shows the speed and the time. Both lines display 0. The temperature indicator displays the current temperature inside the rotor chamber. The bottom line shows the values for the last run.

- b. When the centrifuge lid is open the following display shows:



The image shows a digital display with two lines. The top line displays 'LID OPEN'. The bottom line displays '9 9 15000 r 30.51' on the left and '-10' on the right.

The top line shows the message "Lid open". The bottom line shows the values for the last run.

## Lid Opening

1. Press the OPEN key .



**WARNING** Do not reach into the crack between the lid and the housing. The lid is drawn shut automatically.

Use the emergency release only for malfunctions and power failures (see “[Mechanical Emergency Door Release](#)” on [page 7-2](#)).

## Close Lid

2. Close the lid by pressing down on it lightly in the middle or on both sides of it. Two locks close the lid completely.

**Note** The lid should audibly click into place.

## Rotor Installation

The approved rotors for the Heraeus Multifuge X3 F / X3 FR are listed in section “[Rotor Selection](#)” on [page 1-6](#). Use only the rotors and accessories from this list in the centrifuge.



**CAUTION** Unapproved or incorrectly combined accessories can cause serious damage to the centrifuge.

The centrifuge is equipped with an AutoLock™ locking system. This system is used to automatically lock the rotor to the centrifuge spindle. The rotor does not have to be bolted on to the centrifuge spindle.

Proceed as follows:

3. Open the lid of the centrifuge and if necessary remove any dust, foreign objects or residue from the chamber.  
AutoLock™ and o-ring must be clean and undamaged.

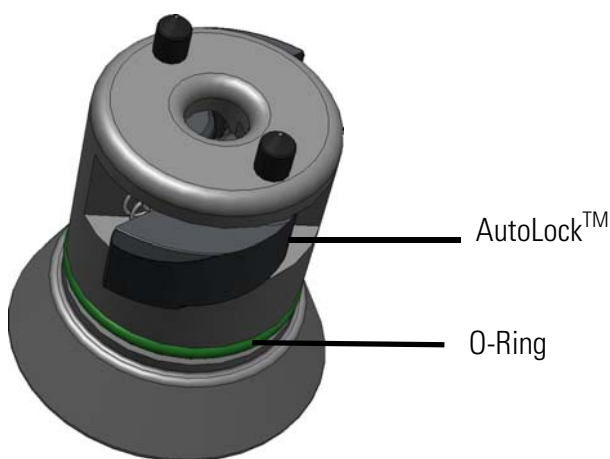

**Figure 4-1.** AutoLock™

4. Place the rotor over the centrifuge spindle and let it slide slowly down the centrifuge spindle. The rotor clicks automatically into place.



**CAUTION** Do not force the rotor onto the centrifuge spindle. If the rotor is very light, then it may be necessary to press it onto the centrifuge spindle with a bit of pressure.

5. Check if the rotor is properly installed by lifting it slightly on the handle. If the rotor can be pulled up, then it must be reclamped to the centrifuge spindle.



**WARNING** If the rotor cannot be properly locked in place after several attempts, then the AutoLock™ is defective and you are not permitted to operate the rotor. Check for any damage to the rotor: Damaged rotors must not be used. Keep the centrifuge spindle area of the rotor clear of objects.



**CAUTION** Check that the rotor is properly locked on the centrifuge spindle before each use by pulling it at its handle.

6. If available close the rotor with the rotor lid.



Be sure to check all sealings before starting any aerosol-tight applications.  
See the information in the rotor instruction manual.

7. The display shows:

## Entering Parameters

### Acceleration curve

The Heraeus Multifuge X3 F / X3 FR offers you a total of 9 acceleration and 10 braking curves with which samples and gradients can be centrifuged.

After the centrifuge is turned on, the last running profile selected is shown.

1. Press the ACC DEC key  once in order to open the acceleration profile selection menu.  
The display shows the message "Set acceleration".



2. Select the desired profile by entering a digit between 1-9 on the numeric pad. Curve number 1 is the slowest and curve number 9 the fastest.
3. Confirm your entry by pressing ENTER .

### Braking curve

1. Press the ACC DEC key  twice in order to open the braking curve selection menu.  
The display shows the message "Set deceleration".



2. Select the desired curve by entering a digit between 1-9 on the numeric pad. Curve number 1 is the slowest and curve number 10 the fastest.
3. Confirm your entry by pressing ENTER .

### Preselecting Speed / RCF

1. Press the SPEED key .
- The display shows the "RPM" or the "RCF"-value depending on the display setting. Press the

TOGGLE key  to toggle between the two modes.



2. Enter the desired value using the numeric pad.  
The digits show in sequential order.
3. Confirm your entry by pressing ENTER .  
Your entry will be automatically confirmed if you do not press any key for 5 seconds.

**Note** If an extremely low RCF value has been selected, it will be corrected automatically if the resulting speed is less than 300 rpm. This is because 300 rpm is the lowest selectable speed.

### Explanation of RCF Value

The relative centrifugal force is given as a multiple of the force of gravity  $g$ . It is a unitless numerical value which is used to compare the separation or sedimentation capacity of various devices, since it is independent of the type of device. Only the centrifuging radius and the speed come into play in it:

$$RCF = 11.18 \times \left\langle \frac{n}{1000} \right\rangle^2 \times r$$

$r$  = centrifuging radius in cm

$n$  = Rotational speed in rpm

The maximum RCF value is related to the maximum radius of the tube opening.

Remember that this value is reduced depending on the tubes and adapters used.

This can be accounted for in the calculation above if required.

### Running time preselection

1. Press the TIME key  in order to open the runtime selection menu.  
The display shows the message "Set Time".  
Enter the desired runtime in hh.mm



2. Press the TIME key  repeatedly to switch over to mm:ss or Hold mode respectively.



3. Enter the desired runtime using the numeric pad.  
The digits show in sequential order.
4. Confirm your entry by pressing ENTER .  
Your entry will be automatically confirmed if you do not press any key for 5 seconds.

While the centrifuge is in operation, two different values can be displayed. The total running time and the running time after reaching the maximum speed.

Press the CHANGE key  to toggle between the two display modes.

### Continuous operation

During continuous operation, the centrifuge will continue running until you stop it manually with the STOP key .

### Run time mode

Use the TOGGLE key  to set the run time counter start.

### AT START

When AT START is lit, the running time will be counted right from pressing the START key .

### AT SPEED

When AT SPEED is lit, the running time will be counted once the preset speed or the preset RCF-value respectively have been reached. In this case, the selected acceleration curve has no effect on the running time.

### Preselecting the temperature

You can preselect temperatures between -10 °C and +40 °C.

While the centrifuge is in operation, two different values can be displayed. The sample temperature and the chamber temperature. Press the TOGGLE key  to toggle between the two display modes.



### AIR

When AIR is lit, the temperature inside the rotor chamber will be controlled. This setting is recommended when using the centrifuges pretemp feature.

## SAMPLE

When SAMPLE is lit, the temperature of the sample will be controlled.

To set the temperature, proceed as follows:

1. Press the TEMPERATURE key  in order to open the temperature selection menu.  
The display shows the messages "Temperature". Depending on the display mode setting, the value shown corresponds either to the sample temperature or to the inside chamber temperature. Press the TOGGLE key  to toggle between the two modes.



The LCD display shows the text "Set temp" on the left. To the right, there are four numerical values: "0", "0.00", "25", and "-10".

2. Enter the desired temperature using the numeric pad.  
The digits show in sequential order.
3. Confirm your entry by pressing ENTER .  
Your entry will be automatically confirmed if you do not press any key for 5 seconds.

## Prewarming or precooling the centrifuge

For setting the pretemp value for the centrifuge proceed as follows:

1. Hold down the TEMPERATURE key  for a minimum of three seconds to open the temperature selection menu.  
The display shows the message "Set PreTemp".



The LCD display shows the text "LID OPEN" on the top line and "Set PreTemp" on the bottom line. To the right of "Set PreTemp", the numerical value "-10" is displayed.

2. Enter the desired temperature using the numeric pad.  
The digits show in sequential order.
3. Confirm your entry by pressing ENTER .  
Your entry will be automatically confirmed if you do not press any key for 5 seconds.



The LCD display shows the text "Close lid to PreTemp" on the left. To the right, there are four numerical values: "0", "0.00", "25", and "-10".

4. The display shows:  
The display shows:



5. Press the START key .  
The rotor chamber is cooled down or heated up to the preset temperature.



6. Press the STOP key .  
The display shows the current temperature.



### Bucket selection

Bucket selection is only possible for swing-out rotors.  
The bucket code corresponds to the last four digits of the bucket catalog number.

1. Press the BUCKET key .  
The display shows the following message:



2. Press the BUCKET key  repeatedly until the bucket being used is displayed.  
Your entry will be automatically confirmed if you do not press any key for 5 seconds.

### Bucket radius

Having entered the bucket code, you may want to specify the radius.

When you use adaptors, you will have to specify the radius. For appropriate values please refer to the instruction manual for the rotor.

1. Press ENTER  to confirm your selection and open the radius input menu.





The default value is marked accordingly. You can either confirm the default value by pressing ENTER  or enter a different radius.



2. Enter the radius using the numeric pad.  
The digits show in sequential order.
3. Press ENTER  to confirm the new radius.

### Setting up a program

1. Enter the program parameters.
2. As described above, please enter braking and acceleration profile, speed/ RCF value, running time, temperatures, bucket code and bucket radius.
3. Press any of the program store keys for 5 seconds.

### Configuring, storing and protecting a program

Programs can be stored and retrieved later by means of the assigned number.

1. Enter the program parameters as described above.
2. Press the program memory key to load any of the programs 1-5.  
Press the DIRECTORY key  in order to load any of the programs 1-99 by means of the numeric pad.  
Enter the program number and confirm with ENTER key .
3. You may want to enter a passcode to protect the data.  
After four seconds the display shows the message "Program saved" or "Program locked".



### Overwriting a passcode-protected program

If you wish to overwrite a passcode-protected program proceed as follows:

1. Select the program you wish to change.
2. Press the program memory key to load any of the programs 1-5.  
Press the DIRECTORY key  in order to load any of the programs 1-99 by means of the numeric pad.

Enter the program number and confirm with ENTER key .



PROGRAM LOCKED  
Passcode to unlock

3. Enter the passcode.

If you enter the wrong password, the following message appears:



PROGRAM LOCKED  
Passcode incorrect

The display restores the current values. Return to step 1.

## Centrifugation

Once the rotor has been properly installed, the main switch has been turned on and the lid has been closed, you can start centrifuging.

If the centrifuge has just been switched on or the last run is more than two hours ago this message will appear in the display:



0 0.00 25  
Check castor brakes!

Check the castor breaks before pressing the START key  again.

### Starting centrifuge program

Press the START key  on the control panel. The centrifuge accelerates to the pre-set speed with the time display active.

If the speed setting is higher than the maximum permissible speed or RCF-value for the particular rotor, then the display will show the message CHECK SET SPEED. The centrifuge decelerates. Please enter a new value.

You cannot open the lid as long as the centrifuge is running.

### Imbalance indicator

If a load is imbalanced, this will be indicated at speed higher than approx. 300 rpm by the message "Imbalanced load".

The run will terminate.

Check the loading and start the centrifuge once again. See the information on proper loading in the rotor instruction manual. For information on troubleshooting, see section “[Troubleshooting by User](#)” on [page 7-3](#).

## Stopping the centrifugation program



### With preset running time

Usually the running time is preset and you only have to wait until the centrifuge stops automatically when the preset time limit expires.

As soon as the speed drops to zero, the message END will appear in the display. By pressing the OPEN key , you can open the lid and remove the centrifuge material.

You can also stop the centrifuging program manually at any time by pressing the STOP key .

### Continuous operation

If you selected continuous operation (see “[Continuous operation](#)” on [page 4-6](#)), you will have to stop the centrifuge manually. Press the STOP key  on the control panel. The centrifuge will be decelerated at the designated rate. The message "END" will illuminate, and after pressing the key OPEN , the lid will open and you can remove the centrifuged material.

## Temperature Adaptation during Standstill

The temperature cannot be adapted until the rotor has been positively identified. For this, the centrifuge must have accelerated to over 500 rpm. The speed display will then show END.

When the rotor is not recognized (lid closed and START key  not yet pressed, speed display "0"), the centrifuge responds by ensuring that the sample cannot freeze regardless of the rotor being used.

## Short-term Centrifugation

For short-term centrifuging, the Heraeus Multifuge X3 F / X3 FR has a PULSE- function.

By holding down the PULSE key , spinning will start and continue until the key is let go.

The centrifuge accelerates and brakes at maximum power. Any rpm or RCF entered beforehand is overridden.

**Note** The centrifuge accelerates to maximum speed, regardless of which rotor was installed.

Check carefully whether you have to maintain a certain speed for your application.

During the acceleration process, time is counted forwards in seconds. The reading stays displayed until the centrifuge lid is opened.

## Removing the Rotor

To remove the rotor, proceed as follows:

1. Open the centrifuge lid.
2. Grab the rotor handle with both hands and press against the green AutoLock™ key. At the same time, pull the rotor directly upwards with both hands and remove it from the centrifuge spindle. Make sure not to tilt the rotor while doing this.

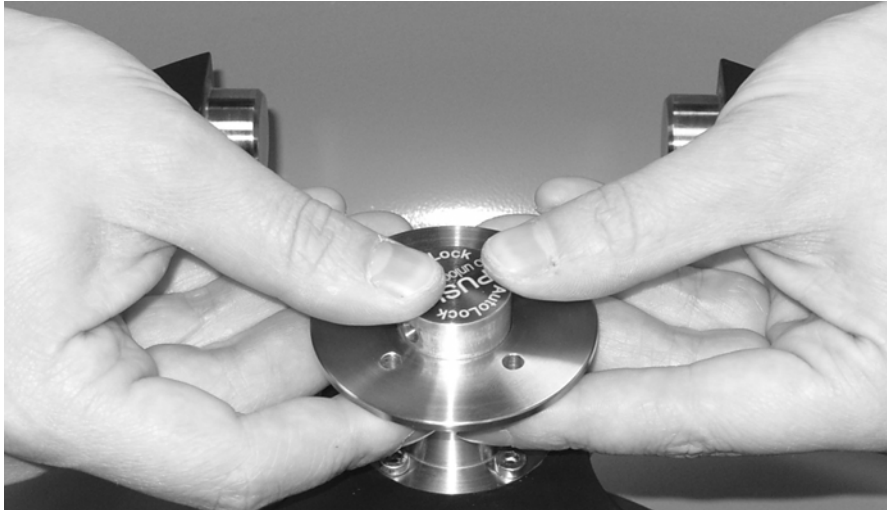

## Aerosol-tight Rotors

When using an aerosol tight lid the rotor can only be removed with the lid closed. This is to protect you and the samples.



**CAUTION** Rotors supplied with a lid for aerosol-tight applications come with a mandrill, which belongs to the AutoLock™. Be sure not to place the lid onto this mandrill to prevent it from being damaged.

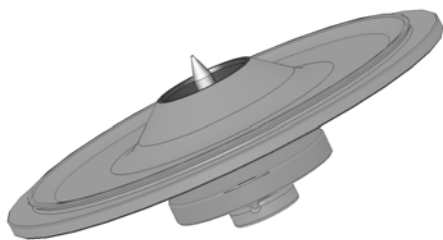

**Figure 4-2.** AutoLock™-lid for aerosol-tight rotors



**WARNING** Mind the AutoLock™-mandrill inside the lid. Do not touch the mandrill.

## Aligning the Centrifuge

1. To turn off the centrifuge put the mains switch to "0".

# System Menu

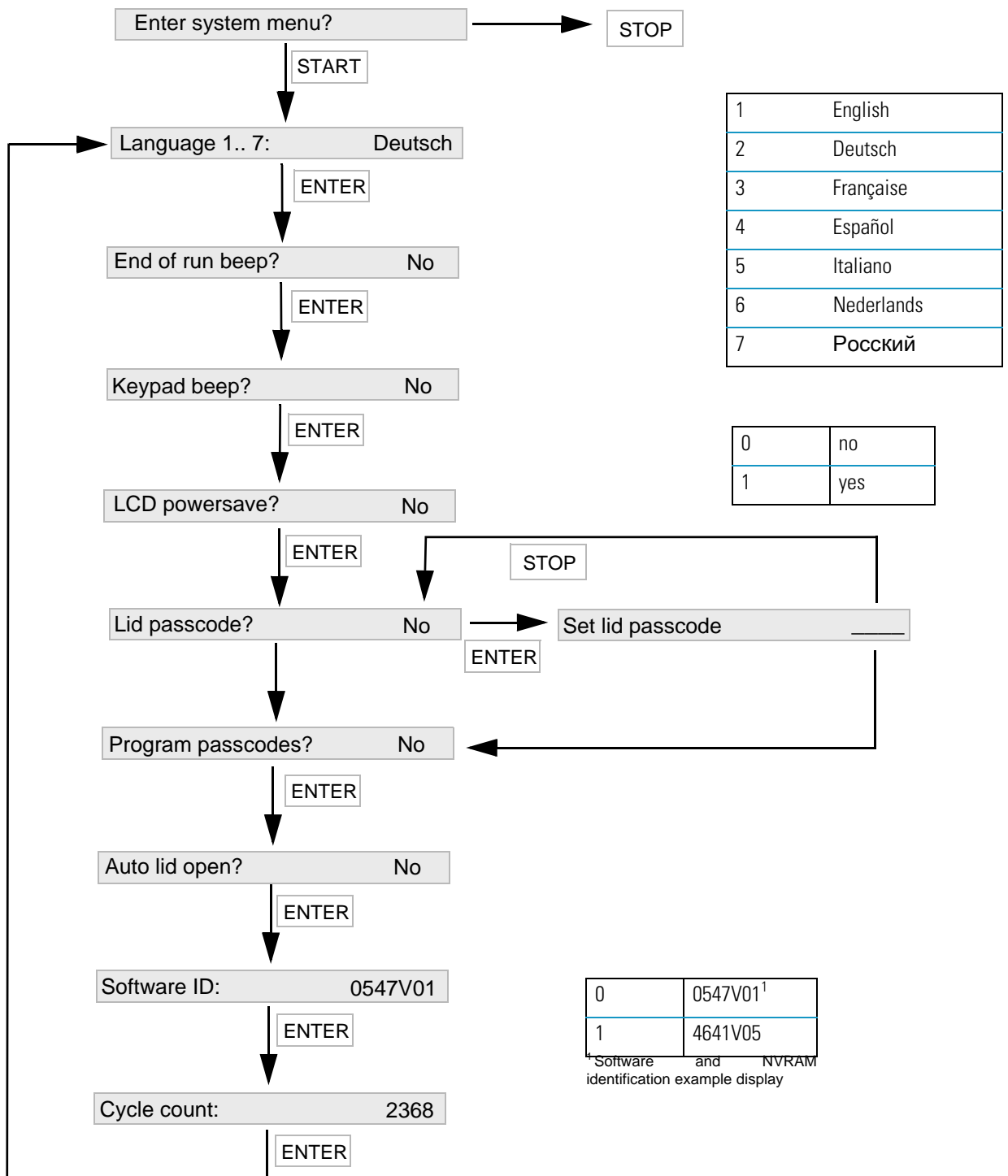

## Description

### Enter system menu

To enter the system menu hold down any of the keys when switching the centrifuge on.

Press the ENTER key  in order to navigate through the system menu.

Press the STOP key  to quit the system menu.

### Language

In order to change the language in the display, press the number next to the desired language in the diagram on the numeric pad.

Press ENTER key  to confirm.

### End of run beep

Press 1 (yes) on the numeric pad if the centrifuge should make beep after the run. Otherwise press 0 (no).

Press ENTER key  to confirm.

### Keypad beep

Press 1 (yes) on the numeric pad if the centrifuge should make beep when pressing any key. Otherwise press 0 (no).

Press ENTER key  to confirm.

### LCD powersave

Press 1 (yes) on the numeric pad if the centrifuge should enter a powersave mode after the run. Otherwise press 0 (no).

Press ENTER key  to confirm.

### Lid passcode

Press 1 (yes) on the numeric pad if the centrifuge door should be protected with a passcode. Enter passcode.

If the door should not be protected with a passcode press 2 (no) on the numeric pad.

Press ENTER key  to confirm.

### Program passcodes

Press 1 (yes) on the numeric pad if the centrifuge programs should be protected with a passcode. Otherwise press 0 (no).

Press ENTER key  to confirm.

### **Auto lid open**

Press 1 (yes) on the numeric pad if the centrifuge should open after the run. Otherwise press 0 (no).

Press ENTER key  to confirm.

### **Software ID**

Here you fine the current software version.

Press ENTER key  to confirm.

### **Cycle count**

Here you fine the current numbers of cycles.

Press ENTER key  to confirm.



# Maintenance and Care

## Contents

- “Cleaning Intervalls” on page 6-2
- “Cleaning” on page 6-2
- “Disinfection” on page 6-3
- “Decontamination” on page 6-4
- “Autoclaving” on page 6-5
- “Service of Thermo Fisher Scientific” on page 6-5

## Cleaning Intervals

For the sake of personal, environmental, and material protection, it is your duty to clean and if necessary disinfect the centrifuge on a regular basis.

Maintenance	Recommended interval
Clean rotor chamber	daily or when polluted
Clean rotor	daily or when polluted
Accessories	daily or when polluted
Cabinet	Once per month
Ventilation holes	Every six months



**CAUTION** Refrain from using any other cleaning or decontamination procedure than those recommended here, if you are not entirely sure that the intended procedure is safe for the equipment.  
Use only approved cleansers.  
If in doubt, contact Thermo Fisher Scientific.

## Cleaning

When cleaning centrifug

- Use warm water with a neutral solvent.
- Never use caustic cleaning agents such as soap suds, phosphoric acid, bleaching solutions or scrubbing powder.
- Rinse the cavities out thoroughly.
- Use a soft brush without metal bristles to remove stubborn residue.
- Afterwards rinse with distilled water.
- Place the rotors on a plastic grate with their cavities pointing down.
- If drying boxes are used, the temperature must never exceed 50 °C, since higher temperatures could damage the material and shorten the lifetime of the parts.
- Use only disinfectants with a pH of 6-8.
- Dry aluminum parts off with a soft cloth.
- After cleaning, treat the entire surface of aluminum parts with corrosion protection oil (7000 9824). Also treat the cavities with oil.
- Store the aluminum parts at room temperature or in a cold-storage room with the cavities pointing down.



**CAUTION** Before using any cleaning or decontamination methods except those recommended by the manufacturer, users should check with the manufacturer that the proposed method will not damage the equipment.

Clean centrifuge and accessories as follows:

1. Open the centrifuge.
2. Turn off the centrifuge.
3. Pull out the power supply plug.
4. Grasp the rotor with both hands and lift it vertically off the centrifuge spindle.
5. Remove the centrifuge tubes and adaptors.
6. Use a neutral cleaning agent with a pH value between 6 and 8 for cleaning.
7. Dry all of the rotors and accessories after cleaning with a cloth or in a warm air cabinet at a maximum temperature of 50°C.
  - After cleaning, treat the entire surface of aluminum parts with corrosion protection oil (7000 9824). Also treat the cavities with oil.
  - Treat the bolt of the swing out rotor with bolt grease (75003786).



**CAUTION** When cleaning, do not allow liquids, especially organic solvents, to get on the drive shaft or the bearings of the centrifuge. Organic solvents break down the grease in the motor bearing. The drive shaft could freeze up.

After some applications there might be ice in the rotor chamber. Let the ice melt and drain it off. Clean the rotor chamber as described above.

## Disinfection

Disinfect the centrifuge immediately whenever infectious material has spilled during centrifugation.



**WARNING** Infectious material can get into the centrifuge when a tube breaks or as a result of spills. Keep in mind the risk of infection when touching the rotor and take all necessary precautions. In case of contamination, make sure that others are not put at risk. Decontaminate the affected parts immediately. Take other precautions if needed.

The rotor chamber and the rotor should be treated preferably with a neutral disinfectant.



**CAUTION** Before using any cleaning or decontamination methods except those recommended by the manufacturer, users should check with the manufacturer that the proposed method will not damage the equipment. Observe the safety precautions and handling instructions for the cleaning agents used.

Contact the Service Department of Thermo Fisher Scientific for questions regarding the use of other disinfectants.

Disinfect the rotor and accessories as follows:

1. Open the centrifuge.
2. Turn off the centrifuge.
3. Pull out the power supply plug.
4. Grasp the rotor with both hands and lift it vertically off the centrifuge spindle.
5. Remove the centrifuge tubes and adaptors and dispose of them or disinfect them.
6. Treat the rotor and accessories according to the instructions for the disinfectant. Adhere strictly to the given application times.
7. Be sure the disinfectant can drain off the rotor.
8. Rinse the rotor and accessories thoroughly with water.
9. Dispose of the disinfectant according to the applicable guidelines.
10. Dry all of the rotors and accessories after cleaning with a cloth or in a warm air cabinet at a maximum temperature of 50°C.
  - After cleaning, treat the entire surface of aluminum parts with corrosion protection oil (7000 9824). Also treat the cavities with oil.
  - Treat the bold of the swing out rotor with bold grease (75003786).

## Decontamination

Decantamine the centrifuge immediately whenever radioactive material has spilled during centrifugation.



**WARNING** Radioactive material can get into the centrifuge when a tube breaks or as a result of spills. Keep in mind the risk of infection when touching the rotor and take all necessary precautions.

In case of contamination, make sure that others are not put at risk.

Decontaminate the affected parts immediately.

Take other precautions if need be.



**CAUTION** Before using any cleaning or decontamination methods except those recommended by the manufacturer, users should check with the manufacturer that the proposed method will not damage the equipment.

For general radioactive decontamination use a solution of equal parts of 70% ethanol, 10% SDS and water.

1. Open the centrifuge.
2. Turn off the centrifuge.
3. Pull out the power supply plug.

4. Grasp the rotor with both hands and lift it vertically off the centrifuge spindle.
5. Remove the centrifuge tubes and adaptors and dispose of them or disinfect them.
6. Rinse the rotor first with ethanol and then with de-ionized water.
  - Adhere strictly to the given application times.
7. Be sure the decontamination solution can drain off the rotor.
8. Rinse the rotor and accessories thoroughly with water.
9. Dispose of the decontamination solution according to the applicable guidelines.
10. Dry all of the rotors and accessories after cleaning with a cloth or in a warm air cabinet at a maximum temperature of 50°C.
  - After cleaning, treat the entire surface of aluminum parts with corrosion protection oil (7000 9824). Also treat the cavities with oil.
  - Tread the bolt of the swing out rotor with bolt grease (75003786).

## Autoclaving

1. Before autoclaving clean rotor and accessories as described above.
2. Place the rotor on a flat surface.
  - Rotors and adapter can be autoclaved at 121 °C.
  - The maximum permissible autoclave cycle is 20 minutes at 121 °C.

**Note** No chemical additives are permitted in the steam.



**CAUTION** Never exceed the permitted temperature and duration when autoclaving. If the rotor shows signs of corrosion or wear, it must be replaced.

## Service of Thermo Fisher Scientific

Thermo Fisher Scientific recommends having the centrifuge and accessories serviced once a year by an authorized service technician. The service technicians check the following:

- the electrical equipment
- the suitability of the set-up site
- the lid lock and the safety system
- the rotor
- the fixation of the rotor and the drive shaft

Thermo Fisher Scientific offers inspection and service contracts for this work. Any necessary repairs are performed for free during the warranty period and afterwards for a charge. This is only valid if the centrifuge has only been maintained by a Thermo Fisher Scientific service technician.

# Trouble Shooting

## Contents

- “Mechanical Emergency Door Release” on page 7-2
- “Troubleshooting by User” on page 7-3
- “When to contact Customer Service” on page 7-5

## Mechanical Emergency Door Release

During a power failure, you will not be able to open the centrifuge lid with the regular electric lid release. A mechanical override is provided to allow sample recovery in the case of an emergency. However, this should be used only in emergencies and after the rotor has come to a complete stop.



**WARNING** The rotor can still be spinning at high speed. If touched, it can cause serious injuries.

Always wait a few minutes until the rotor has come to a stop without braking. The brake does not work when there is no current. The braking process lasts much longer than usual.

Proceed as follows:

1. Make sure the rotor has stopped (view port in the lid).



**WARNING** Never use your hand or other tools to brake the rotor.

2. Pull out the power supply plug.
3. On the back of the housing are two black plastic plugs which you can pry out of the back plate with a screwdriver or a knife. Pull the release cord attached to it at the same time to trigger the mechanical lid release. The lid will open and the samples can be removed.

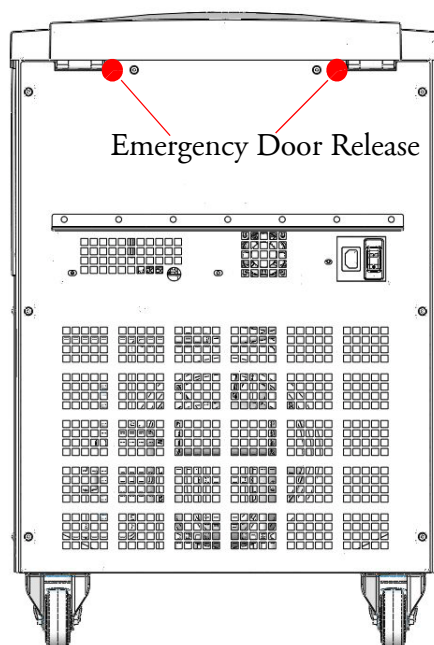

**Figure 7-1.** Emergency Door Release

**Note** You need to pull both levers in order to unlock both locks.

4. Push the cord back into the centrifuge and mount the plug.



5. Reconnect the centrifuge once the power has been restored. Switch on the centrifuge. Press the OPEN key  to have the door locks operative again.



**WARNING** If you pull only one lever or you do not pressed the OPEN key  to have the door locks operative again, the door might open while the rotor os still spinning.

## Troubleshooting by User



If problems occur other than those listed in this table, the authorized customer service representative must be contacted.

Failure message	Problem with centrifuge	Possible causes and cures
Overtemperature	The centrifuge cannot be operated. The run does not start or the centrifuge runs down without being braked.	Overheating in chamber. Check the function of the refrigeration unit. Clean the air inlet for the condenser. Restart the centrifuge. If an error message appears again, inform Customer Service.
Incorrect bucket ID	The centrifuge cannot be operated. The run does not start or the centrifuge runs down without being braked.	Bucket code is undefined for the rotor detected, check the set points for the given bucket code. Is it permitted to use the current bucket in the rotor currently mounted? Restart the centrifuge. If an error message appears again, inform Customer Service.
Unapproved rotor	The centrifuge cannot be operated. The run does not start or the centrifuge runs down without being braked.	Rotor code is not in the rotor table. Is it permitted to use the rotor currently mounted in this device? Restart the centrifuge. If an error message appears again, inform Customer Service.
Rotor ID failure	The centrifuge cannot be operated. The run does not start or the centrifuge runs down without being braked.	The rotor could not be identified. Check to see if the rotor is properly installed. Restart the centrifuge. If an error message appears again, inform Customer Service.
Lid blocked	Centrifuge does not open	Restart the centrifuge. The emergency lid release enables you to retrieve your samples. If an error message appears again, inform Customer Service.
Motor overtemp.	The centrifuge cannot be operated. The run does not start or the centrifuge runs down without being braked.	Restart the centrifuge. If an error message appears again, inform Customer Service.

<b>Failure message</b>	<b>Problem with centrifuge</b>	<b>Possible causes and cures</b>
PCB overtemp.	The centrifuge cannot be operated. The run does not start or the centrifuge runs down without being braked.	Restart the centrifuge. If an error message appears again, inform Customer Service.
Emergency release	The centrifuge cannot be operated. The run does not start or the centrifuge runs down without being braked.	The lid opens while the device is running. Close the lid and restart the centrifuge. If an error message appears again, inform Customer Service.
Imbalanced load	The centrifuge cannot be operated. The run does not start or the centrifuge runs down without being braked.	Imbalance detected. Check the load placed in the rotor. Check that the rotor cross bolts are well greased. Restart the centrifuge. If an error message appears again, inform Customer Service.
Check Set Speed	The centrifuge cannot be operated. The run does not start or the centrifuge runs down without being braked.	The set point speed is higher than the maximum rotor speed. Correct the value. Restart the centrifuge. If an error message appears again, inform Customer Service.
E-01 - E-12	The centrifuge cannot be operated. The run does not start or the centrifuge runs down without being braked.	Error during the self-test of the centrifuge program and the electronics. Restart the centrifuge. If an error message appears again, inform Customer Service.
E-13	The centrifuge cannot be operated. The run does not start or the centrifuge runs down without being braked.	The check sum in the data memory is incorrect. The software corrects errors automatically. Check the values of the set point settings, etc. Restart the centrifuge. If an error message appears again, inform Customer Service.
E-15-E-16	Temperature sensor broken / controller defective	Malfunction in the temperature detection. Restart the centrifuge. If an error message appears again, inform Customer Service.
E-17	Speed for rotor detection exceeded	Restart the centrifuge. If an error message appears again, inform Customer Service.
E-21-E-22	The centrifuge cannot be operated. The run does not start or the centrifuge runs down without being braked.	The rotor could not be identified. Check to see if the rotor is properly installed. Restart the centrifuge. If an error message appears again, inform Customer Service.
E-23	The centrifuge cannot be operated. The run does not start or the centrifuge runs down without being braked.	The speed control measurement returned a different result. Restart the centrifuge. If an error message appears again, inform Customer Service.
E-25-E-27	The centrifuge cannot be operated. The run does not start or the centrifuge runs down without being braked.	Time has expired for the lid lock drive while opening the lid. Restart the centrifuge. If an error message appears again, inform Customer Service.

Failure message	Problem with centrifuge	Possible causes and cures
E-28	The centrifuge cannot be operated. The run does not start or the centrifuge runs down without being braked.	Error during the self-test of the centrifuge program and the electronics. Restart the centrifuge. If an error message appears again, inform Customer Service.
E-29	The centrifuge cannot be operated. The run does not start.	Check whether you selected the right bucket. Is it easy to turn the rotor when the lid is open? Does the rotor rub against the device? Restart the centrifuge. If an error message appears again, inform Customer Service.
E-30	The centrifuge cannot be operated. The run does not start or the centrifuge runs down without being braked.	Restart the centrifuge. If an error message appears again, inform Customer Service.
E-33	The centrifuge cannot be operated. The run does not start or the centrifuge runs down without being braked.	Overpressure in the refrigeration unit. Clean the air inlet for the condenser. Restart the centrifuge. If an error message appears again, inform Customer Service.
E-34-E-36	The centrifuge cannot be operated. The run does not start or the centrifuge runs down without being braked.	Error during the self-test of the centrifuge program and the electronics. Restart the centrifuge. If an error message appears again, inform Customer Service.
E-40	The centrifuge cannot be operated. The run does not start or the centrifuge runs down without being braked.	The centrifuge accelerates too slowly. Is the rotor properly installed? Check whether you selected the right bucket. Is it easy to turn the rotor when the lid is open? Does the rotor rub against the device? Restart the centrifuge. If an error message appears again, inform Customer Service.
E-41-E-74	The centrifuge cannot be operated. The run does not start or the centrifuge runs down without being braked.	Error during the self-test of the centrifuge program and the electronics. Restart the centrifuge. If an error message appears again, inform Customer Service.

## When to contact Customer Service

If you need to contact customer service, please provide the order no. and the serial no. of your device. This information can be found on the back near the inlet for the power supply cable.

To identify the software version, proceed as follows:

1. Hold down any of the keys and then switch on the centrifuge.  
You enter the system menu.
2. Press the START key .

## 7 Trouble Shooting

When to contact Customer Service

3. Press and hold the ENTER key , until the following message is displayed:

Software ID:                   XXXXXXXX

4. Communicate the software version to the service technician.

# Chemical Compatibility Chart

CHEMICAL	MATERIAL	ALUMINUM	ANODIC COATING for ALUMINUM	BUNA N	CELLULOSE ACETATE BUTYRATE	POLYURETHANE ROTOR PAINT	COMPOSITE Carbon Fiber/Epoxy	DELRIN®	ETHYLENE PROPYLENE	GLASS	NEOPRENE	NORYL®	NYLON	PET <sup>1</sup> , POLYCLEAR®, CLEARCRIMP®, CCCLEARCRIMP®	POLYALLUMER	POLYCARBONATE	POLYESTER, GLASS THERMOSET	POLYETHERIMIDE	POLYRTHYLENE	POLYPROPYLENE	POLYSULFONE	POLYVINYL CHLORIDE	RULON A®, TEFLON®	SILICONE RUBBER	STAINLESS STEEL	TITANIUM	TYGON®	VITON®	
2-mercaptoethanol		S	S	U	-	S	M	S	-	S	U	S	S	U	S	S	-	S	S	S	S	U	S	S	S	S	S	S	
Acetaldehyde		S	-	U	U	-	-	-	M	-	U	-	-	-	M	U	U	U	M	M	-	M	S	U	-	S	-	U	
Acetone		M	S	U	U	S	U	M	S	S	U	U	S	U	S	U	U	U	S	S	U	U	S	M	M	S	U	U	
Acetonitrile		S	S	U	-	S	M	S	-	S	S	U	S	U	M	U	U	-	S	M	U	U	S	S	S	S	U	U	
Alconox®		U	U	S	-	S	S	S	-	S	S	S	S	S	S	M	S	S	S	S	S	S	S	S	S	S	S	U	
Allyl Alcohol		-	-	-	U	-	-	S	-	-	-	-	S	-	S	S	M	S	S	S	S	-	M	S	-	-	S	-	
Aluminum Chloride		U	U	S	S	S	S	U	S	S	S	S	M	S	S	S	S	-	S	S	S	S	S	M	U	U	S	S	
Formic Acid (100%)		-	S	M	U	-	-	U	-	-	-	-	U	-	S	M	U	U	S	S	-	U	S	-	U	S	-	U	
Ammonium Acetate		S	S	U	-	S	S	S	-	S	S	S	S	S	S	U	-	S	S	S	S	S	S	S	S	S	S	S	
Ammonium Carbonate		M	S	U	S	S	S	S	S	S	S	S	S	S	U	U	-	S	S	S	S	S	S	S	M	S	S	S	
Ammonium Hydroxide (10%)		U	U	S	U	S	S	M	S	S	S	S	S	-	S	U	M	S	S	S	S	S	S	S	S	S	S	M	S
Ammonium Hydroxide (28%)		U	U	S	U	S	U	M	S	S	S	S	S	U	S	U	M	S	S	S	S	S	S	S	S	S	S	M	S
Ammonium Hydroxide (conc.)		U	U	U	U	S	U	M	S	-	S	-	S	U	S	U	U	S	S	S	-	M	S	S	S	S	-	U	
Ammonium Phosphate		U	-	S	-	S	S	S	S	S	S	S	S	-	S	S	M	-	S	S	S	S	S	S	M	S	S	S	
Ammonium Sulfate		U	M	S	-	S	S	U	S	S	S	S	S	S	S	S	S	-	S	S	S	S	S	S	U	S	S	U	
Amyl Alcohol		S	-	M	U	-	-	S	S	-	M	-	S	-	M	S	S	S	S	M	-	-	-	U	-	S	-	M	
Aniline		S	S	U	U	S	U	S	M	S	U	U	U	U	U	U	U	-	S	M	U	U	S	S	S	S	U	S	
Sodium Hydroxide (<1%)		U	-	M	S	S	S	-	-	S	M	S	S	-	S	M	M	S	S	S	S	S	S	M	S	S	-	U	
Sodium Hydroxide (10%)		U	-	M	U	-	-	U	-	M	M	S	S	U	S	U	U	S	S	S	S	S	S	M	S	S	-	U	
Barium Salts		M	U	S	-	S	S	S	S	S	S	S	S	S	S	M	-	S	S	S	S	S	S	M	S	S	S	S	
Benzene		S	S	U	U	S	U	M	U	S	U	U	S	U	U	U	M	U	M	U	U	U	S	U	U	S	U	S	

# A Chemical Compatibility Chart

CHEMICAL	MATERIAL																											
	ALUMINUM	ANODIC COATING for ALUMINUM	BUNA N	CELLULOSE ACETATE BUTYRATE	POLYURETHANE ROTOR PAINT	COMPOSITE Carbon Fiber/Epoxy	DELRIN®	ETHYLENE PROPYLENE	GLASS	NEOPRENE	NORYL®	NYLON	PET <sup>1</sup> , POLYCLEAR®, CLEARCRIMP®, CCCLEARCRIMP®	POLYALLUMER	POLYCARBONATE	POLYESTER, GLASS THERMOSET	POLYTHERMIDE	POLYRTHYLENE	POLYPROPYLENE	POLYSULFONE	POLYVINYL CHLORIDE	RULON A®, TEFLON®	SILICONE RUBBER	STAINLESS STEEL	TITANIUM	TYGON®	VITON®	
Benzyl Alcohol	S	-	U	U	-	-	M	M	-	M	-	S	U	U	U	U	U	U	U	-	M	S	M	-	S	-	S	
Boric Acid	U	S	S	M	S	S	U	S	S	S	S	S	S	S	S	S	U	S	S	S	S	S	S	S	S	S	S	S
Cesium Acetate	M	-	S	-	S	S	S	-	S	S	S	S	-	S	S	-	-	S	S	S	S	S	S	M	S	S	S	
Cesium Bromide	M	S	S	-	S	S	S	-	S	S	S	S	S	S	S	-	-	S	S	S	S	S	S	M	S	S	S	
Cesium Chloride	M	S	S	U	S	S	S	-	S	S	S	S	S	S	S	-	-	S	S	S	S	S	S	M	S	S	S	
Cesium Formate	M	S	S	-	S	S	S	-	S	S	S	S	S	S	S	-	-	S	S	S	S	S	S	M	S	S	S	
Cesium Iodide	M	S	S	-	S	S	S	-	S	S	S	S	S	S	S	-	-	S	S	S	S	S	S	M	S	S	S	
Cesium Sulfate	M	S	S	-	S	S	S	-	S	S	S	S	S	S	S	-	-	S	S	S	S	S	S	M	S	S	S	
Chloroform	U	U	U	U	S	S	M	U	S	U	U	M	U	M	U	U	U	M	M	U	U	S	U	U	U	M	S	
Chromic Acid (10%)	U	-	U	U	S	U	U	-	S	S	S	U	S	S	M	U	M	S	S	U	M	S	M	U	S	S	S	
Chromic Acid (50%)	U	-	U	U	-	U	U	-	-	-	S	U	U	S	M	U	M	S	S	U	M	S	-	U	M	-	S	
Cresol Mixture	S	S	U	-	-	-	S	-	S	U	U	U	U	U	U	-	-	U	U	-	U	S	S	S	S	U	S	
Cyclohexane	S	S	S	-	S	S	S	U	S	U	S	S	U	U	U	M	S	M	U	M	M	S	U	M	M	U	S	
Deoxycholate	S	S	S	-	S	S	S	-	S	S	S	S	S	S	S	-	-	S	S	S	S	S	S	S	S	S	S	
Distilled Water	S	S	S	S	S	S	S	S	S	S	S	S	S	S	S	S	S	S	S	S	S	S	S	S	S	S	S	
Dextran	M	S	S	S	S	S	S	-	S	S	S	S	S	S	S	S	S	S	S	S	S	S	S	M	S	S	S	
Diethyl Ether	S	S	U	U	S	S	S	U	S	U	U	S	U	U	U	U	U	U	U	U	U	S	S	S	S	M	U	
Diethyl Ketone	S	-	U	U	-	-	M	-	S	U	-	S	-	M	U	U	U	M	M	-	U	S	-	-	S	U	U	
Diethylpyrocarbonate	S	S	U	-	S	S	S	-	S	S	U	S	U	S	U	-	-	S	S	S	M	S	S	S	S	S	S	
Dimethylsulfoxide	S	S	U	U	S	S	S	-	S	U	S	S	U	S	U	U	-	S	S	U	U	S	S	S	U	U	U	
Dioxane	M	S	U	U	S	S	M	M	S	U	U	S	U	M	U	U	-	M	M	M	U	S	S	S	S	U	U	
Ferric Chloride	U	U	S	-	-	-	M	S	-	M	-	S	-	S	-	-	-	S	S	-	-	-	M	U	S	-	S	
Acetic Acid (Glacial)	S	S	U	U	S	S	U	M	S	U	S	U	U	U	U	U	M	S	U	M	U	S	U	U	S	-	U	
Acetic Acid (5%)	S	S	M	S	S	S	M	S	S	S	S	S	M	S	S	S	S	S	S	S	M	S	S	M	S	S	M	
Acetic Acid (60%)	S	S	U	U	S	S	U	-	S	M	S	U	U	M	U	S	M	S	M	S	M	S	M	U	S	M	U	
Ethyl Acetate	M	M	U	U	S	S	M	M	S	S	U	S	U	M	U	U	-	S	S	U	U	S	M	M	S	U	U	
Ethyl Alcohol (50%)	S	S	S	S	S	S	M	S	S	S	S	S	U	S	U	S	S	S	S	S	S	S	S	M	S	M	U	
Ethyl Alcohol (95%)	S	S	S	U	S	S	M	S	S	S	S	S	U	S	U	-	S	S	S	M	S	S	S	U	S	M	U	
Ethylene Dichloride	S	-	U	U	-	-	S	M	-	U	U	S	U	U	U	U	U	U	U	-	U	S	U	-	S	-	S	

CHEMICAL	MATERIAL																											
	ALUMINUM	ANODIC COATING for ALUMINUM	BUNA N	CELLULOSE ACETATE BUTYRATE	POLYURETHANE ROTOR PAINT	COMPOSITE Carbon Fiber/Epoxy	DELRIN®	ETHYLENE PROPYLENE	GLASS	NEOPRENE	NORYL®	NYLON	PET <sup>1</sup> , POLYCLEAR®, CLEARCRIMP®, CCCLEARCRIMP®	POLYALLUMER	POLYCARBONATE	POLYESTER, GLASS THERMOSET	POLYETHERIMIDE	POLYETHYLENE	POLYPROPYLENE	POLYSULFONE	POLYVINYL CHLORIDE	RULON A®, TEFLON®	SILICONE RUBBER	STAINLESS STEEL	TITANIUM	TYGON®	VITON®	
Ethylene Glycol	S	S	S	S	S	S	S	S	S	S	S	S	-	S	U	S	S	S	S	S	S	S	S	M	S	M	S	
Ethylene Oxide Vapor	S	-	U	-	-	U	-	-	S	U	-	S	-	S	M	-	-	S	S	S	U	S	U	S	S	S	U	
Ficoll-Hypaque®	M	S	S	-	S	S	S	-	S	S	S	S	-	S	S	-	S	S	S	S	S	S	S	M	S	S	S	
Hydrofluoric Acid (10%)	U	U	U	M	-	-	U	-	-	U	U	S	-	S	M	U	S	S	S	S	M	S	U	U	U	-	-	
Hydrofluoric Acid (50%)	U	U	U	U	-	-	U	-	-	U	U	U	U	S	U	U	U	S	S	M	M	S	U	U	U	-	M	
Hydrochloric Acid (conc.)	U	U	U	U	-	U	U	M	-	U	M	U	U	M	U	U	U	-	S	-	U	S	U	U	U	-	-	
Formaldehyde (40%)	M	M	M	S	S	S	S	M	S	S	S	S	M	S	S	S	U	S	S	M	S	S	S	M	S	M	U	
Glutaraldehyde	S	S	S	S	-	-	S	-	S	S	S	S	S	S	S	-	-	S	S	S	-	-	S	S	S	-	-	
Glycerol	M	S	S	-	S	S	S	S	S	S	S	S	S	S	S	S	-	S	S	S	S	S	S	S	S	S	S	
Guanidine Hydrochloride	U	U	S	-	S	S	S	-	S	S	S	S	S	S	S	-	-	S	S	S	S	S	S	U	S	S	S	
Haemo-Sol®	S	S	S	-	-	-	S	-	S	S	S	S	S	S	S	-	-	S	S	S	S	S	S	S	S	S	S	
Hexane	S	S	S	-	S	S	S	-	S	S	U	S	U	M	U	S	S	U	S	S	M	S	U	S	S	U	S	
Isobutyl Alcohol	-	-	M	U	-	-	S	S	-	U	-	S	U	S	S	M	S	S	S	-	S	S	S	-	S	-	S	
Isopropyl Alcohol	M	M	M	U	S	S	S	S	S	U	S	S	U	S	U	M	S	S	S	S	S	S	S	M	M	M	S	
Iodoacetic Acid	S	S	M	-	S	S	S	-	S	M	S	S	M	S	S	-	M	S	S	S	S	S	M	S	S	M	M	
Potassium Bromide	U	S	S	-	S	S	S	-	S	S	S	S	S	S	S	S	S	S	S	-	S	S	S	M	S	S	S	
Potassium Carbonate	M	U	S	S	S	S	S	-	S	S	S	S	S	U	S	S	S	S	S	S	S	S	S	S	S	S	S	
Potassium Chloride	U	S	S	-	S	S	S	S	S	S	S	S	S	S	-	S	S	S	S	S	S	S	U	S	S	S	S	
Potassium Hydroxide (5%)	U	U	S	S	S	S	M	-	S	S	S	S	-	S	U	S	S	S	S	S	S	S	M	U	M	S	U	
Potassium Hydroxide (conc.)	U	U	M	U	-	-	M	-	M	S	S	-	U	M	U	U	U	S	M	-	M	U	-	U	U	-	U	
Potassium Permanganate	S	S	S	-	S	S	S	-	S	S	S	U	S	S	S	M	-	S	M	S	U	S	S	M	S	U	S	
Calcium Chloride	M	U	S	S	S	S	S	S	S	S	S	S	S	S	M	S	-	S	S	S	S	S	S	M	S	S	S	
Calcium Hypochlorite	M	-	U	-	S	M	M	S	-	M	-	S	-	S	M	S	-	S	S	S	M	S	M	U	S	-	S	
Kerosene	S	S	S	-	S	S	S	U	S	M	U	S	U	M	M	S	-	M	M	M	S	S	U	S	S	U	S	
Sodium Chloride (10%)	S	-	S	S	S	S	S	-	-	-	-	S	S	S	S	S	-	S	S	S	S	-	S	S	M	-	S	
Sodium Chloride (sat'd)	U	-	S	U	S	S	S	-	-	-	-	S	S	S	S	S	-	S	S	-	S	-	S	S	M	-	S	
Carbon Tetrachloride	U	U	M	S	S	U	M	U	S	U	U	S	U	M	U	S	S	M	M	S	M	M	M	U	S	S	S	
Aqua Regia	U	-	U	U	-	-	U	-	-	-	-	-	U	U	U	U	U	U	U	-	-	-	-	-	S	-	M	
Solution 555 (20%)	S	S	S	-	-	-	S	-	S	S	S	S	S	S	S	-	-	S	S	S	-	S	S	S	S	S	S	

# A Chemical Compatibility Chart

CHEMICAL	MATERIAL																											
	ALUMINUM	ANODIC COATING for ALUMINUM	BUNA N	CELLULOSE ACETATE BUTYRATE	POLYURETHANE ROTOR PAINT	COMPOSITE Carbon Fiber/Epoxy	DELRIN®	ETHYLENE PROPYLENE	GLASS	NEOPRENE	NORYL®	NYLON	PET <sup>1</sup> , POLYCLEAR®, CLEARCRIMP®, CCCLEARCRIMP®	POLYALLUMER	POLYCARBONATE	POLYESTER, GLASS THERMOSET	POLYETHERIMIDE	POLYRTHYLENE	POLYPROPYLENE	POLYSULFONE	POLYVINYL CHLORIDE	RULON A®, TEFLON®	SILICONE RUBBER	STAINLESS STEEL	TITANIUM	TYGON®	VITON®	
Magnesium Chloride	M	S	S	-	S	S	S	S	S	S	S	S	S	S	S	S	S	S	S	S	S	S	S	M	S	S	S	
Mercaptoacetic Acid	U	S	U	-	S	M	S	-	S	M	S	U	U	U	U	-	S	U	U	S	M	S	U	S	S	S	S	
Methyl Alcohol	S	S	S	U	S	S	M	S	S	S	S	S	U	S	U	M	S	S	S	S	S	S	S	M	S	M	U	
Methylene Chloride	U	U	U	U	M	S	S	U	S	U	U	S	U	U	U	U	U	M	U	U	U	S	S	M	U	S	U	
Methyl Ethyl Ketone	S	S	U	U	S	S	M	S	S	U	U	S	U	S	U	U	U	S	S	U	U	S	S	S	U	U		
Metrizamide®	M	S	S	-	S	S	S	-	S	S	S	S	-	S	S	-	-	S	S	S	S	S	S	M	S	S	S	
Lactic Acid (100%)	-	-	S	-	-	-	-	-	-	M	S	U	-	S	S	S	M	S	S	-	M	S	M	S	S	-	S	
Lactic Acid (20%)	-	-	S	S	-	-	-	-	-	M	S	M	-	S	S	S	S	S	S	S	M	S	M	S	S	-	S	
N-Butyl Alcohol	S	-	S	U	-	-	S	-	-	S	M	-	U	S	M	S	S	S	S	M	M	S	M	-	S	-	S	
N-Butyl Phthalate	S	S	U	-	S	S	S	-	S	U	U	S	U	U	U	M	-	U	U	S	U	S	M	M	S	U	S	
N, N-Dimethylformamide	S	S	S	U	S	M	S	-	S	S	U	S	U	S	U	U	-	S	S	U	U	S	M	S	S	S	U	
Sodium Borate	M	S	S	S	S	S	S	S	S	S	S	U	S	S	S	S	-	S	S	S	S	S	M	S	S	S	S	
Sodium Bromide	U	S	S	-	S	S	S	-	S	S	S	S	S	S	S	S	-	S	S	S	S	S	S	M	S	S	S	
Sodium Carbonate (2%)	M	U	S	S	S	S	S	S	S	S	S	S	S	S	U	S	S	S	S	S	S	S	S	S	S	S	S	
Sodium Dodecyl Sulfate	S	S	S	-	S	S	S	-	S	S	S	S	S	S	S	-	S	S	S	S	S	S	S	S	S	S	S	
Sodium Hypochlorite (5%)	U	U	M	S	S	M	U	S	S	M	S	S	S	M	S	S	S	S	M	S	S	S	M	U	S	M	S	
Sodium Iodide	M	S	S	-	S	S	S	-	S	S	S	S	S	S	S	-	-	S	S	S	S	S	S	M	S	S	S	
Sodium Nitrate	S	S	S	-	S	S	S	S	S	S	S	S	S	S	S	S	-	S	S	S	S	S	U	S	S	S	S	
Sodium Sulfate	U	S	S	-	S	S	S	S	S	S	S	S	S	S	S	S	S	S	S	S	S	S	S	M	S	S	S	
Sodium Sulfide	S	-	S	S	-	-	-	S	-	-	-	S	S	S	U	U	-	-	S	-	-	-	S	S	M	-	S	
Sodium Sulfite	S	S	S	-	S	S	S	S	M	S	S	S	S	S	S	M	-	S	S	S	S	S	S	S	S	S	S	
Nickel Salts	U	S	S	S	S	S	-	S	S	S	-	-	S	S	S	S	-	S	S	S	S	S	M	S	S	S	S	
Oils (Petroleum)	S	S	S	-	-	-	S	U	S	S	S	S	U	U	M	S	M	U	U	S	S	S	U	S	S	S	S	
Oils (Other)	S	-	S	-	-	-	S	M	S	S	S	S	U	S	S	S	S	U	S	S	S	S	-	S	S	M	S	
Oleic Acid	S	-	U	S	S	S	U	U	S	U	S	S	M	S	S	S	S	S	S	S	S	S	M	U	S	M	M	
Oxalic Acid	U	U	M	S	S	S	U	S	S	S	S	S	U	S	U	S	S	S	S	S	S	S	U	M	S	S	S	
Perchloric Acid (10%)	U	-	U	-	S	U	U	-	S	M	M	-	-	M	U	M	S	M	M	-	M	S	U	-	S	-	S	
Perchloric Acid (70%)	U	U	U	-	-	U	U	-	S	U	M	U	U	M	U	U	U	M	M	U	M	S	U	U	S	U	S	
Phenol (5%)	U	S	U	-	S	M	M	-	S	U	M	U	U	S	U	M	S	M	S	U	U	S	U	M	M	M	S	



CHEMICAL	MATERIAL																										
	ALUMINUM	ANODIC COATING for ALUMINUM	BUNA N	CELLULOSE ACETATE BUTYRATE	POLYURETHANE ROTOR PAINT	COMPOSITE Carbon Fiber/Epoxy	DELRIN®	ETHYLENE PROPYLENE	GLASS	NEOPRENE	NORYL®	NYLON	PET <sup>1</sup> , POLYCLEAR®, CLEARCRIMP®, CCCLEARCRIMP®	POLYALLUMER	POLYCARBONATE	POLYESTER, GLASS THERMOSET	POLYETHERIMIDE	POLYRTHYLENE	POLYPROPYLENE	POLYSULFONE	POLYVINYL CHLORIDE	RULON A®, TEFLON®	SILICONE RUBBER	STAINLESS STEEL	TITANIUM	TYGON®	VITON®
Phenol (50%)	U	S	U	-	S	U	M	-	S	U	M	U	U	U	U	U	S	U	M	U	U	S	U	U	U	M	S
Phosphoric Acid (10%)	U	U	M	S	S	S	U	S	S	S	S	U	-	S	S	S	S	S	S	S	S	S	U	M	U	S	S
Phosphoric Acid (conc.)	U	U	M	M	-	-	U	S	-	M	S	U	U	M	M	S	S	S	M	S	M	S	U	M	U	-	S
Physiologic Media (Serum, Urine)	M	S	S	S	-	-	S	-	S	S	S	S	S	S	S	S	S	S	S	S	S	S	S	S	S	S	S
Picric Acid	S	S	U	-	S	M	S	S	S	M	S	U	S	S	S	U	S	S	S	S	U	S	U	M	S	M	S
Pyridine (50%)	U	S	U	U	S	U	U	-	U	S	S	U	U	M	U	U	-	U	S	M	U	S	S	U	U	U	U
Rubidium Bromide	M	S	S	-	S	S	S	-	S	S	S	S	S	S	S	-	-	S	S	S	S	S	S	M	S	S	S
Rubidium Chloride	M	S	S	-	S	S	S	-	S	S	S	S	S	S	S	-	-	S	S	S	S	S	S	M	S	S	S
Sucrose	M	S	S	-	S	S	S	S	S	S	S	S	S	S	S	S	S	S	S	S	S	S	S	S	S	S	S
Sucrose, Alkaline	M	S	S	-	S	S	S	-	S	S	S	S	S	U	S	S	S	S	S	S	S	S	S	M	S	S	S
Sulfosalicylic Acid	U	U	S	S	S	S	S	-	S	S	S	U	S	S	S	-	S	S	S	-	S	S	U	S	S	S	S
Nitric Acid (10%)	U	S	U	S	S	U	U	-	S	U	S	U	-	S	S	S	S	S	S	S	S	S	M	S	S	S	S
Nitric Acid (50%)	U	S	U	M	S	U	U	-	S	U	S	U	U	M	M	U	M	M	M	S	S	S	U	S	S	M	S
Nitric Acid (95%)	U	-	U	U	-	U	U	-	-	U	U	U	U	M	U	U	U	U	M	U	U	S	U	S	S	-	S
Hydrochloric Acid (10%)	U	U	M	S	S	S	U	-	S	S	S	U	U	S	U	S	S	S	S	S	S	S	S	U	M	S	S
Hydrochloric Acid (50%)	U	U	U	U	S	U	U	-	S	M	S	U	U	M	U	U	S	S	S	S	M	S	M	U	U	M	M
Sulfuric Acid (10%)	M	U	U	S	S	U	U	-	S	S	M	U	S	S	S	S	S	S	S	S	S	S	U	U	U	S	S
Sulfuric Acid (50%)	M	U	U	U	S	U	U	-	S	S	M	U	U	S	U	U	M	S	S	S	S	S	U	U	U	M	S
Sulfuric Acid (conc.)	M	U	U	U	-	U	U	M	-	-	M	U	U	S	U	U	U	M	S	U	M	S	U	U	U	-	S
Stearic Acid	S	-	S	-	-	-	S	M	S	S	S	S	-	S	S	S	S	S	S	S	S	S	M	M	S	S	S
Tetrahydrofuran	S	S	U	U	S	U	U	M	S	U	U	S	U	U	U	-	M	U	U	U	U	S	U	S	S	U	U
Toluene	S	S	U	U	S	S	M	U	S	U	U	S	U	U	S	U	U	M	U	U	U	S	U	S	U	U	M
Trichloroacetic Acid	U	U	U	-	S	S	U	M	S	U	S	U	U	S	M	-	M	S	S	U	U	S	U	U	U	M	U
Trichloroethane	S	-	U	-	-	-	M	U	-	U	-	S	U	U	U	U	U	U	U	U	U	S	U	-	S	-	S
Trichloroethylene	-	-	U	U	-	-	-	U	-	U	-	S	U	U	U	U	U	U	U	U	U	S	U	-	U	-	S
Trisodium Phosphate	-	-	-	S	-	-	M	-	-	-	-	-	-	S	-	-	S	S	S	-	-	S	-	-	S	-	S
Tris Buffer (neutral pH)	U	S	S	S	S	S	S	-	S	S	S	S	S	S	S	S	S	S	S	S	S	S	S	S	S	S	S
Triton X-100®	S	S	S	-	S	S	S	-	S	S	S	S	S	S	S	S	S	S	S	S	S	S	S	S	S	S	S
Urea	S	-	U	S	S	S	S	-	-	-	-	S	S	S	M	S	S	S	S	-	S	S	S	M	S	-	S

## A Chemical Compatibility Chart

CHEMICAL	MATERIAL	ALUMINUM	ANODIC COATING for ALUMINUM	BUNA N	CELLULOSE ACETATE BUTYRATE	POLYURETHANE ROTOR PAINT	COMPOSITE Carbon Fiber/Epoxy	DELRIN®	ETHYLENE PROPYLENE	GLASS	NEOPRENE	NORYL®	NYLON	PET <sup>1</sup> , POLYCLEAR®, CLEARCRIMP®, CCCLEARCRIMP®	POLYALLUMER	POLYCARBONATE	POLYESTER, GLASS THERMOSET	POLYETHERIMIDE	POLYETHYLENE	POLYPROPYLENE	POLYSULFONE	POLYVINYL CHLORIDE	RULON A®, TEFLON®	SILICONE RUBBER	STAINLESS STEEL	TITANIUM	TYGON®	VITON®
Hydrogen Peroxide (10%)		U	U	M	S	S	U	U	-	S	S	S	U	S	S	S	M	U	S	S	S	S	S	S	M	S	U	S
Hydrogen Peroxide (3%)		S	M	S	S	S	-	S	-	S	S	S	S	S	S	S	S	M	S	S	S	S	S	S	S	S	S	S
Xylene		S	S	U	S	S	S	M	U	S	U	U	U	U	U	U	M	U	M	U	U	U	S	U	M	S	U	S
Zinc Chloride		U	U	S	S	S	S	U	S	S	S	S	S	S	S	S	S	S	S	S	S	S	S	S	U	S	S	S
Zinc Sulfate		U	S	S	-	S	S	S	S	S	S	S	S	S	S	S	S	S	S	S	S	S	S	S	S	S	S	S
Citric Acid (10%)		M	S	S	M	S	S	M	S	S	S	S	S	S	S	S	S	M	S	S	S	S	S	S	S	S	S	S

<sup>1</sup>Polyethyleneterephthalate

### Key

S Satisfactory

M Moderate attack, may be satisfactory for use in centrifuge depending on length of exposure, speed involved, etc. Suggest testing under actual conditions of use.

U Unsatisfactory, not recommended.

-- Performance unknown; suggest testing, using sample to avoid loss of valuable material.

Chemical resistance data is included only as a guide to product use. No organized chemical resistance data exists for materials under the stress of centrifugation. When in doubt we recommend pretesting sample lots.

## Contact Information

United States	866-9-THERMO
	+1 866 984 3766

Canada	+1 866 984 3766
--------	-----------------

Austria	+43 1 801 400
---------	---------------

Belgium	+32 2 482 30 30
---------	-----------------

Germany	08001 536 376
	+49 6184 90 6940

France	+33 2 2803 2180
	+33 2 2803 2000

Italy	+39 02 02 95059 341
-------	---------------------

Netherlands	+31 76 571 4440
-------------	-----------------

Nordic / Baltic Countries	+35 89 329 100
---------------------------	----------------

Russia	+7 (812) 703 42 15
--------	--------------------

## **B** Contact Information

Spain +34 932 23 09 18

---

Portugal +34 932 23 09 18

---

Switzerland +41 44 454 12 12

---

UK / Ireland +44 870 609 9203

---

China +86 21 6865 4588

---

+86 10 8419 3588

---

India +91 22 6716 2200

---

Japan +81 45 453 9220

---

Other Asian Countries +852 2885 4613

---

Latin America +1 866 984 3766

---

Other Countries +49 6184 90 6940

---

+33 2 2803 2180

---

# Index

- A**
- Acceleration curve ..... 4-4
  - Accident Prevention ..... iv
  - Aerosol-tight Rotors ..... 4-12
  - Aligning the Centrifuge ..... 2-4
  - Autoclaving ..... 6-5
- B**
- Braking curve ..... 4-4
  - Bucket radius ..... 4-8
  - Bucket selection ..... 4-8
- C**
- Care ..... 6-1
  - Centrifugation ..... 4-10
  - Cleaning ..... 6-2
  - Cleaning Intervals ..... 6-2
  - Close Lid ..... 4-2
  - Continuous Operation ..... 4-6, 4-11
  - Control Panel ..... 3-2
- D**
- Decontamination ..... 6-4
  - Disinfection ..... 6-3
- E**
- Emergency Door Release ..... 7-2
  - Entering Parameters ..... 4-4
  - Explanation of RCF Value ..... 4-5
- F**
- Failure message ..... 7-3
  - Features ..... 1-5
- I**
- Imbalance indicator ..... 4-10
  - Intended Use ..... v
- K**
- Keys ..... 3-2
  - Kundendienst ..... 6-5, 7-5
- L**
- Lid Opening ..... 4-2
  - Location ..... 2-4
- M**
- Mains Connection ..... 2-5
  - Mains Supply ..... 1-5, 2-6
  - Maintenance ..... 6-1
- O**
- Operation ..... 4-1
  - Overwriting a passcode-protected program ..... 4-9
  - Overwriting a program ..... 4-9
- P**
- Passcode ..... 4-9
  - Precautions ..... iv
  - Preface ..... iii
  - Preselecting RCF ..... 4-4
  - Preselecting Speed ..... 4-4
  - Preselecting the temperature ..... 4-6
  - Preset Running Time ..... 4-11
  - Prewarming or Precooling ..... 4-7
  - Prewarming or precooling the centrifuge ..... 4-7
- R**
- Removing the Rotor ..... 4-12
  - Rotor Installation ..... 4-2
  - Rotor Selection ..... 1-6
  - Running time preselection ..... 4-5
- S**
- Safety features ..... 1-2

**Index:**

Safety zone .....	2-4
Select Program .....	4-9
Short-term Centrifugation .....	4-11
Starting centrifuge program .....	4-10
Stopping the centrifugation program .....	4-11
Storage .....	2-6
Switch on Centrifuge .....	4-2

**T**

Technical Data .....	1-3
Temperature Adaptation .....	4-11
Transporting the Centrifuge .....	2-4
Trouble Shooting .....	7-1

**IVD**